

OPARCK LIFTS

OPARCK



SHAOXING DINGGAO MECHANICAL EQUIPMENT CO.,LTD.

OPARION

COMPANY PROFILE 公司简介

绍兴鼎高机械设备有限公司是一家集研发、制造、高品质、节能、环保、安全为一体的汽车检测设备及服务于一体化的专业化汽车举升设备生产企业。公司拥有国际先进的生产设备，设备齐全的开发实验室。严格执行ISO9001质量体系 and CE认证要求，严格执行国家有关规定。ERP电脑管理系统及最佳管理模式，确保产品不良率低于2/1000。

鼎高人坚信合作、创新、共赢。以优质的服务、优质的产品换取您的信任，建立长期友好合作的伙伴关系。先进的生产设备，精湛的工艺，良好的信誉保证，是我们回报客户的最好方式。

今天，鼎高人以优质的产品推动行业发展，并与世界著名的汽车维修设备代理公司签约。现已完善销售网络，在全国各大城市设立办事处。为世界汽车维修行业用户提供优质的产品和优质的服务，力争成为中国汽车维修设备行业的典范。

Shaoxing dinggao mechanical equipment Co., Ltd is a collection of r & d and manufacture of high quality, energy saving, environmental protection and safety of automobile testing equipment and services in a body's specialized auto lift equipment production enterprise. The company has international advanced production equipment, Fully equipped development laboratory. Strictly implement the ISO9001 quality system and CE certification requirements. Strictly implements national related instructions. ERP computer management system and best management mode to ensure the product defective rate is less than 2/1000.

Dinggao people believe that cooperation, innovation, win-win situation. With the best service, best quality products in exchange for your trust and establish a long-term friendly and cooperative partner ship. The advanced production equipment, exquisite technology, good reputation guarantee, is the best way we reward our customers.

Today, Dinggao people with high quality products to promote the development of the industry, And sign with the world famous auto maintenance equipment agency. Now complete sales network, set up offices in the domestic major cities nationwide. Providing quality products and excellent service for world auto maintenance industry user , To be a model for China's auto maintenance equipment industry.

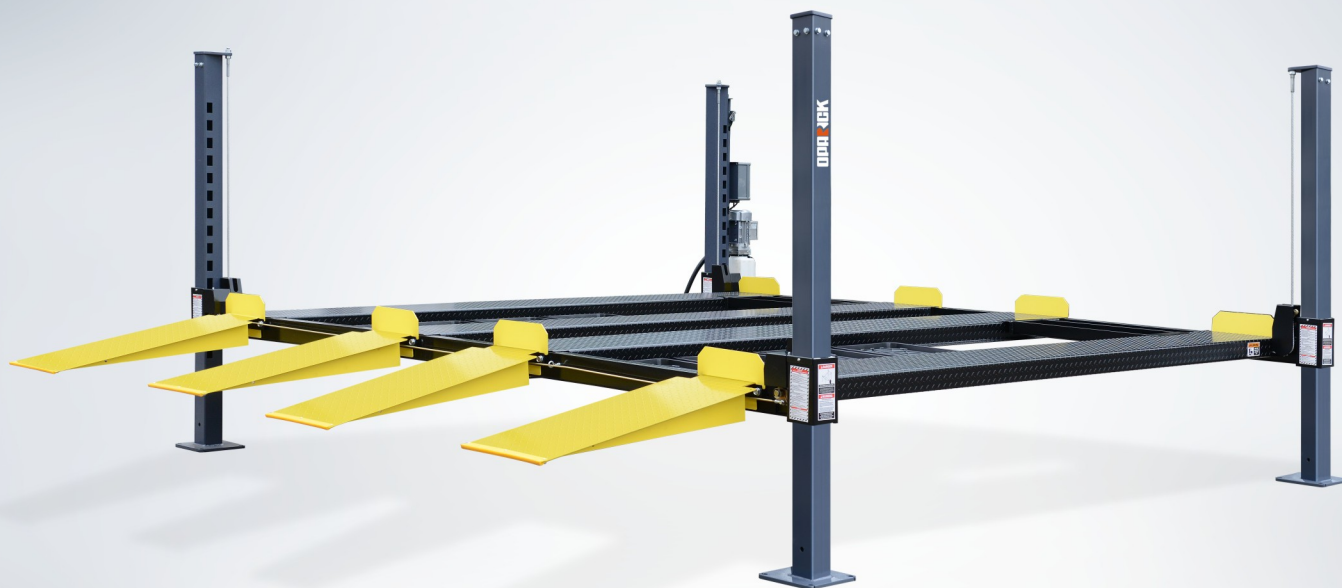

PP-11FW

DOUBLE PARKING GARAGE

双联停车库

更多信息请登录
More information please login
www.oparck.com
www.sxdinggao.en.alibaba.com

产品说明

- 它是理想的停车库，最大举升高度为1927mm，举升重量为11000lbs。
- 手动安全解锁和钢丝绳断绳保护机构，双重安全机构，更安全。
- 采用高密度滑块，使用寿命长。
- 油管上的防爆节流阀可防止油管爆裂。
- 高强度防滑板平台整体成形。
- 防止车辆移动的特殊刹车块。
- 四辆车可同时停放，节省空间。

PRODUCT DESCRIPTION

- It is the ideal parking garage for vehicles, with a maximum lift of 1927 mm and a lifting capacity of 11,000 lbs.
- Manual safety mechanism and cable breaking protection mechanism, double safety mechanism, safer.
- Use high density slider, long service life.
- Explosion-proof throttle valve on tubing can prevent tubing from bursting and falling rapidly.
- Integral forming of platform with high strength anti-skid plate.
- Special brake block to prevent vehicle from moving.
- Four cars can be parked at the same time to save space.



专注于举升机设备的研发、制造与销售
FOCUS ON R&D, MANUFACTURING AND SALES OF FOUR-COLUMN LIFTING EQUIPMENT

PP-11FW

DOUBLE PARKING GARAGE

双联停车库



技术参数 Technical parameters

型号	Model	PP-11FW
长×宽×高	LxWxH	5250x4617x2076mm
举升高度	Lifting Height	1927mm
举升时间	Lifting Time	50s
柱间长	Length of Columns	3995mm
总长度	Overall Length	5250mm
立柱底板间宽度	Inside Soleplate of Columns Width	4127mm
总宽度	Overall Width	4617mm
平台长度	Platform Length	4200mm
载重量	Lifting Capacity	11000LBS
跑道宽度	Runway Width	475mm
跑道间宽度	Width Between Runway	958mm
包装尺寸1	Packing Size1	4280x570x720mm
包装尺寸2	Packing Size2	4630x570x510mm
毛重1	Gross Weight1	695kg
毛重2	Gross Weight2	690kg

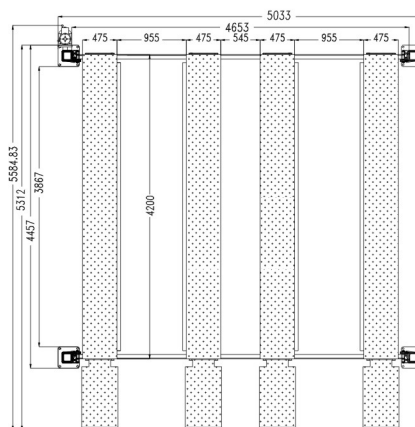
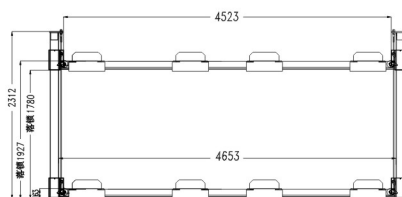

细节说明 Detail



带有黄色滑条的上坡板可以警示人们并保护摩擦。
Up ramp with yellow slider can warn people and protect friction.

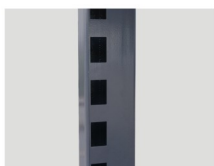

立柱保险机构
Column safety mechanism



带防爆阀的跑道下液压缸。
Hydraulic cylinder under runway with explosion-proof valve.



机械解锁装置
Mechanical unlocking device



主跑道下钢丝绳和滑轮的结构。
The structure of cable and pulley under main runway.



接油盘
Oil-receiving tray

OPARCK

更多信息请登录 More information please login:
www.oparck.com www.sxdinggao.en.alibaba.com

绍兴鼎高机械设备有限公司
SHAOXINGDINGGAOMECHANICAL EQUIPMENT CO., LTD.

浙江省绍兴市袍江工业区马山路186号
NO.186 Mashan Road, Paojiang Industrial Zone, Shaoxing, Zhejiang, China
TEL: 0086-0575-84623366 FAX: 0086-0575-84623331
E-mail: lichao@dinggao.com



www.oparck.com



www.sxdinggao.en.alibaba.com



PP-8SU

FOUR POST PARKING GARAGE LIFT

四柱停车库举升机

更多信息请登录
More information please login
www.oparck.com
www.sxdinggao.en.alibaba.com

产品说明

- 外型美观，节省场地空间
- 电机带动油泵驱动液压油缸，钢丝绳传动，工作环境安静
- 机械安全锁，可任意锁定在设计范围内高度进行作业，安全可靠
- 四个角在锁定位置水平度可以调节
- 油路上装有节流阀一套

PRODUCT DESCRIPTION

- Beautiful appearance, save space
- Motor drive oil pump drive hydraulic cylinder, wire rope drive, quiet working environment
- Mechanical safety lock, can be arbitrarily locked in the design range of the height of the operation, safe and reliable
- The levelness of the four angles in the locked position can be adjusted
- A set of throttle valves is installed in the oil circuit



专注于举升机设备的研发、制造与销售
FOCUS ON R&D, MANUFACTURING AND SALES OF FOUR-COLUMN LIFTING EQUIPMENT



PP-17DH

MULTI-LEVEL PARKING LIFT

三层停车库

更多信息请登录
More information please login
www.oparck.com
www.sxdinggao.en.alibaba.com

PRODUCT DESCRIPTION

- Power Post. The Post that holds the Power Unit. Mount the Power Unit on one of the two Mounting Brackets.
- Power Unit. An electric/hydraulic unit that connects to an electric power source and then provides Hydraulic Fluid to the Hydraulic Cylinder that raises and lowers the Runways.
- Flex Tubes. Not shown. A flexible, black tube that attaches to an opening on the Powerside Runway on one end and to the Power Unit on the other end. Used for protecting the Return Line, Air Line, and Hydraulic Hose (and Microswitch Cable for Upper Platform) as they are routed to the Power Unit. One Flex Tube per Platform.
- Upper Platform. Can hold Vehicles up to 7,000 lbs.
- Lower Platform. Can hold Vehicles up to 9,000 lbs.
- Powerside Runway. On the same side as the Power Post (holds the Power Unit). The Powerside Runway has the Hydraulic Cylinder and the Cables under it. Same for both Platforms.
- Offside Runway. The other Runway. It does not have a Hydraulic Cylinder or Cables under it. Same for both Platforms.
- Aluminum Decks. Sits in between the two Runways. Protects any leakage from falling onto the Vehicle below. Two per Platform.
- Safety Shutoff Bar. Located on the underside of the Upper Platform. The Safety Shutoff Bar stops upward movement of the Lift. If you are raising a Vehicle on the Lower Platform and it hits the Safety Shutoff Bar, the Lift immediately stops moving.
- Crossbeams. Extra structural stability for your Lift. Two Crossbeams connect the Powerside Posts and another two connect the Offside Posts.
- Crossbeam Brackets. Holds the Crossbeams in place, two per Post. Brackets must face the inside of the Lift.
- Drive-up Ramps. The Upper Platform uses a longer set of Ramps, and the Lower Platform uses a shorter set of Ramps. Use them to drive onto and off of the Runways. Two per Platform.
- Tire Stops. Located at the Front of the Lift, Tire Stops prevent the Vehicle's Front Tires from going any further forward. Additionally, we recommend that you chock the Vehicle's Rear Tires. Two per Platform.
- Safety Locks. Once engaged, they hold the Runways in position, even if the power goes out or there is a leak in the Hydraulic Hoses. Your Lift has two columns of Safety Locks per post, spaced every four inches. This lets you lock the Runways at just the right height for what you want to do. This Lift also has a backup Slack Safety system; refer to About Safety Locks for more information. Only leave your Lift on the ground or engaged on a Safety Lock.
- Platform Selector Valve. Controls which Platform is in operation; only one Platform can be raised or lowered at a time.
- Pushbutton Air Valve. Moves the Safety Locks away from the Ladder so that they do not engage as you lower the Lift. Used to lower the Runways.
- Ladders. Pieces of steel that gets installed at the back of each Post; these are part of the Safety Lock system.



PP-17DH

MULTI-LEVEL PARKING LIFT

三层停车库



技术参数 Technical parameters

型号	Model	PP-17DH
长×宽×高	L×W×H	6121×2804×4010mm
上层举升高度	Max. Lifting Height (upper platform)	3689mm
下层举升高度	Max. Lifting Height (lower platform)	1783mm
最小高度	Min Height	270mm
总长	Overall length	6121mm
柱间宽	Inside column width	2552mm
总宽	Overall Width	4010mm
站台长度	Platform Length	4775mm
跑道宽度	Runway Width	482mm
跑道间宽度	Width between runway	1121mm
上层平台承重	Upper platform capacity	7000lbs
下层平台承重	Lower platform capacity	9000lbs

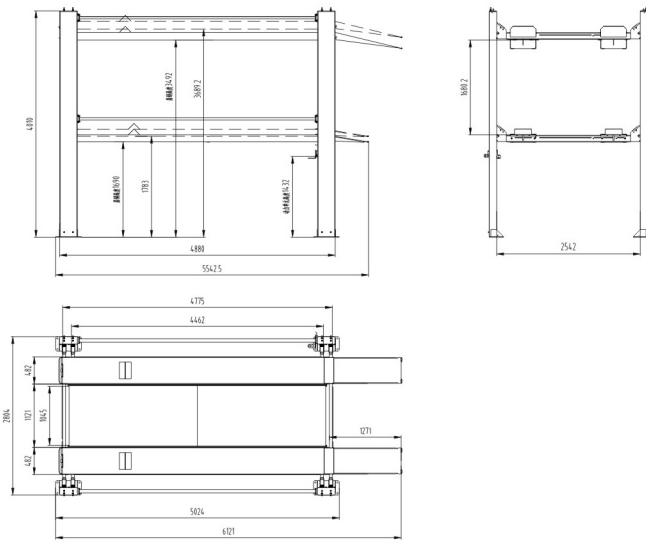

细节说明 Detail



放气气缸
Air cylinder for air release



上主平台下滑轮及电缆
Pulley and cable under upper main platform



限位开关
Limit switch

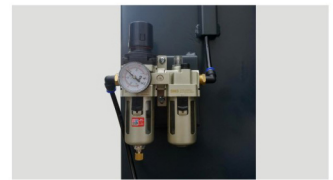

油水分离器
Oil-water separator

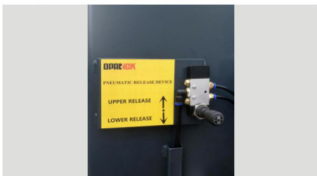

排气装置
Air release device

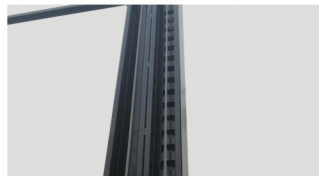

内锁立柱
Lock ladder inside the column

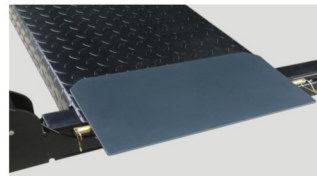

停止运行板
Stop running plate



停止运行板
Stop running plate

OPARICK

更多信息请登录 More information please login:
www.oparick.com www.sxdinggao.en.alibaba.com

绍兴鼎高机械设备有限公司
SHAOXINGDINGGAOMECHANICAL EQUIPMENT CO., LTD.

浙江省绍兴市袍江工业区马山路186号
NO.186 Mashan Road, Paojiang Industrial Zone, Shaoxing, Zhejiang, China
TEL: 0086-0575-84623366 FAX: 0086-0575-84623331
E-mail: lichao@dinggaomechanical.com



www.oparick.com



www.sxdinggao.en.alibaba.com



PP-9SW

DOUBLE PARKING GARAGE

More information please login
www.dinggaojx.cn
www.sxdinggao.en.alibaba.com

PRODUCT DESCRIPTION

- It is the ideal parking garage for vehicles, with a maximum lift of 1845 mm and a lifting capacity of 9,000 lbs.
- Manual safety mechanism and cable breaking protection mechanism, double safety mechanism, safer.
- Use high density slider, long service life.
- Explosion-proof throttle valve on tubing can prevent tubing from bursting and falling rapidly.
- Integral forming of platform with high strength anti-skid plate.
- Special brake block to prevent vehicle from moving.
- Four cars can be parked at the same time to save space.



PP-9SW

DOUBLE PARKING GARAGE



Technical parameters

Model	PP-9SW
LxWxH	5250x4617x2076mm
Lifting Height	1845mm
Lifting Time	50s
Length of Columns	3995mm
Overall Length	5250mm
Inside Soleplate of Columns Width	4127mm
Overall Width	4617mm
Platform Length	4200mm
Lifting Capacity	(9000lbs)4082kg
Runway Width	475mm
Width Between Runway	958mm
Packing Size1	4280x570x720mm
Packing Size2	4630x570x510mm
Gross Weight1	695kg
Gross Weight2	690kg

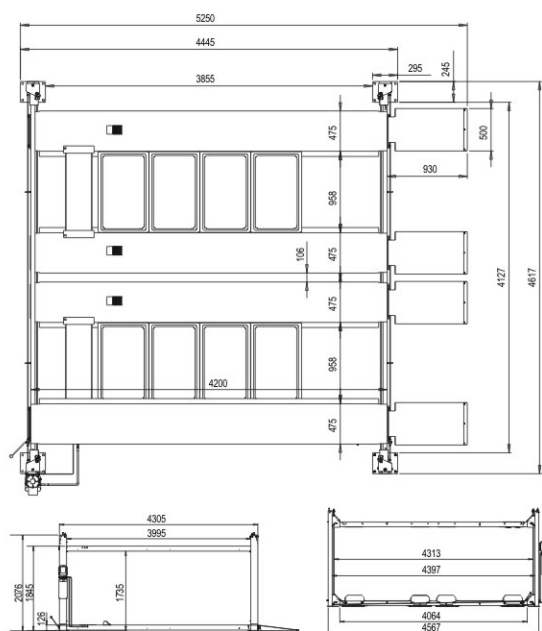

Detail



Up ramp with yellow slider can warn people and protect friction.

Manual release bar.

Hydraulic cylinder under runway with explosion-proof valve.

Safety mechanism for protect quickly declined cause by cable breakage.

The structure of cable and pulley under main runway.

Down limit switch.

OPARICK

SHAOXINGDINGGAOMECHANICAL EQUIPMENT CO., LTD.

NO.186 Mashan Road, Paojiang Industrial Zone, Shaoxing, Zhejiang, China
 TEL: 0086-0575-84623366 FAX: 0086-0575-84623331
 E-mail: lichao@dinggaomechanical.com

More information please login:
www.dinggaojx.cn www.sxdinggao.en.alibaba.com



www.dinggaojx.cn



www.sxdinggao.en.alibaba.com

PP8H

FOUR POST LIFT

四柱举升机



技术参数 Technical parameters

型号	Model	PP-8H
长x宽x高	LxWxH	5249.5x2601x2476mm
举升高度	Lifting Height	2185mm
举升时间	Lifting Time	50s
柱间长	Length of Columns	3995mm
总长度	Overall Length	5249.5mm
立柱底板间宽度	Inside Soleplate of Columns Width	2111mm
总宽度	Overall Width	2601mm
平台长度	Platform Length	4200mm
载重量	Lifting Capacity	(8000LB)3600kg
跑道宽度	Runway Width	475mm
跑道间宽度	Width Between Runway	954mm
包装尺寸	Packing Size	4300x570x725mm
毛重	Gross Weight	840kg

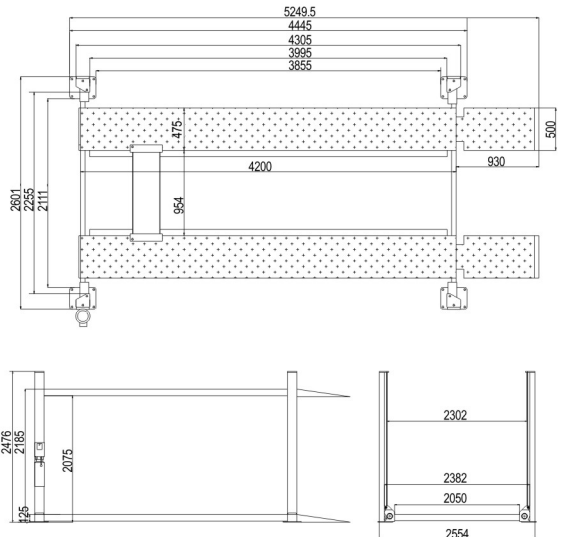

细节说明 Detail



倍增滑轮结构。
Multiplying pulley structure.



防爆阀。
Explosion-proof valve.



移动架在空载时能方便举升机的移动。
Caster kit can make people move lift easy when no-load.



带有黄色滑块的上坡道可以警示人们，并保护摩擦脚轮套件可以使人们在空载时轻松移动和提升。
Up ramp with yellow slider can warn people and protect friction caster kit can make people move lift easy when no-load.



钢丝绳断裂保险机构。
Safety mechanism for protect quickly declined cause by wire rope breakage.



手动保险杆。
Manual safety bar.

OPARICK

更多信息请登录 More information please login:
www.dinggaojx.cn www.sxdinggao.en.alibaba.com

绍兴鼎高机械设备有限公司
SHAOXING DINGGAOMECHANICAL EQUIPMENT CO., LTD.

浙江省绍兴市袍江工业区马山路186号
NO.186 Mashan Road, Paojiang Industrial Zone, Shaoxing, Zhejiang, China
TEL: 0086-0575-84623366 FAX: 0086-0575-84623331
E-mail: lichao@dinggaomechanical.com



www.dinggaojx.cn



www.sxdinggao.en.alibaba.com



PP8H

FOUR POST LIFT

四柱举升机

更多信息请登录
More information please login
www.dinggaojx.cn
www.sxdinggao.en.alibaba.com

产品说明

- 垂直升降停车举升机，是商用车和SUV中大型车辆停放的理想设备，举升高度2185mm，举升重量8000磅。
- 安装方便，结构紧凑，特殊的移动配件使整个装置在空载时移动方便。
- 手动机械保险机构和钢丝绳断裂保护机构，双重安全机构，更安全。
- 它在柱子上使用高密度滑块，使用寿命长。
- 油管上的防爆节流阀，它能防止油管爆裂而引起的快速下落。
- 平台采用高强度防滑花纹板整体成型。
- 专用刹车块可防止车辆移动。
- 可选配二次举升小车，方便车辆维修。

PRODUCT DESCRIPTION

- Vertical rise and fall parking lift, It is the ideal equipment for commercial vehicles and SUV medium and large vehicles parking, Lifting height 2185mm, lifting capacity 8000 pounds.
- Convenient installation, compact structure, the special mobile fitting make the whole device move convenient when no-load.
- Manual mechanical safety organ and wire rope fracture protective mechanism, double safety mechanism, more safety.
- It use high density slide blocks in the columns, Long service life.
- Explosion-proof throttle valve on the oil tube, It can prevent falling fast because of oil tube burst.
- The platform is made of high strength antiskid pattern plate overall molding.
- The special brake block can prevent the vehicles moving.
- Optional rolling jack, convenient for maintenance vehicles.



PP8HL

FOUR POST LIFT

四柱举升机



技术参数 Technical parameters

型号	Model	PP-8HL
长x宽x高	LxWxH	5748.5x2974x2476mm
举升高度	Lifting Height	2185mm
举升时间	Lifting Time	70s
柱间长	Length of Columns	4494mm
总长度	Overall Length	5748.5mm
立柱底板间宽度	Inside Soleplate of Columns Width	2221mm
总宽度	Overall Width	2974mm
平台长度	Platform Length	4699mm
载重量	Lifting Capacity	(8000LB)3600kg
跑道宽度	Runway Width	508mm
跑道间宽度	Width Between Runway	965mm
包装尺寸	Packing Size	4800x570x725mm
毛重	Gross Weight	890kg

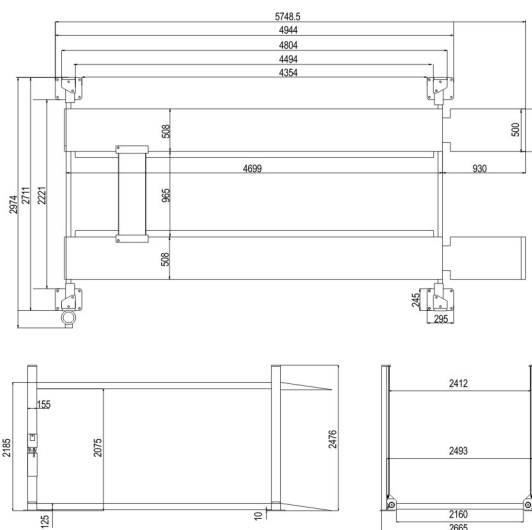

细节说明 Detail

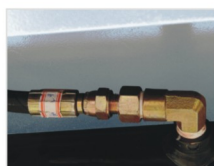

防爆阀。
Explosion-proof valve.



倍增滑轮结构。
Multiplying pulley structure.

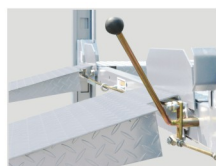

手动保险杆。
Manual safety bar for release.



钢丝绳断裂保险机构。
Safety mechanism for protect quickly declined caused by wire rope breakage.



移动架在空载时能方便举升机的移动。
Caster kit can make people move lift easy when no-load.



带有黄色滑条的上坡板可以警示人们并保护地面摩擦。
Up ramp with yellow slider can Warn people and protect friction.

OPARICK

更多信息请登录 More information please login:
www.dinggaojx.cn www.sxdinggao.en.alibaba.com

绍兴鼎高机械设备有限公司
SHAOXINGDINGGAOMECHANICAL EQUIPMENT CO., LTD.

浙江省绍兴市袍江工业区马山路186号
NO.186 Mashan Road, Paojiang Industrial Zone, Shaoxing, Zhejiang, China
TEL: 0086-0575-84623366 FAX: 0086-0575-84623331
E-mail: lichao@dinggaomechanical.com



www.dinggaojx.cn



www.sxdinggao.en.alibaba.com



PP8HL

FOUR POST LIFT

四柱举升机

更多信息请登录
More information please login
www.dinggaojx.cn
www.sxdinggao.en.alibaba.com

产品说明

- 垂直升降停车举升机，是商用车和 SUV 中大型车辆停放的理想设备，举升高度 2185mm，举升重量 8000 磅。
- 安装方便，结构紧凑，特殊的移动配件使整个装置在空载时移动方便。
- 手动机械安全机构和钢丝绳断裂保护机构，双重安全机构，更安全。
- 立柱采用高密度滑块，使用寿命长。
- 油管上的防爆节流阀。它能防止油管爆裂而引起的快速下落。
- 平台采用高强度防滑花纹板整体成型。
- 专用刹车块可防止车辆移动。
- 可选配二次举升小车，方便车辆维修。

PRODUCT DESCRIPTION

- Vertical rise and fall parking lift, It is the ideal equipment for commercial vehicles and SUV medium and large vehicles parking, Lifting height 2185mm, lifting capacity 8000 pounds.
- Convenient installation, compact structure, the special mobile fitting make the whole device move convenient when no-load.
- Manual mechanical safety organ and wire rope fracture protective mechanism, double safety mechanism, more safety.
- It use high density slide blocks in the columns, Long service life.
- Explosion-proof throttle valve on the oil tube. It can prevent falling fast because of oil tube burst.
- The platform is made of high strength antiskid pattern plate overall molding.
- The special brake block can prevent the vehicles moving.
- Optional rolling jack, convenient for maintenance vehicles.



PP8S

FOUR POST LIFT

四柱举升机



技术参数 Technical parameters

型号	Model	PP-8S
长x宽x高	LxWxH	5249.5x2864x2076mm
举升高度	Lifting Height	1845mm
举升时间	Lifting Time	50s
柱间长	Length of Columns	3995mm
总长度	Overall Length	5249.5mm
立柱底板间宽度	Inside Soleplate of Columns Width	2111mm
总宽度	Overall Width	2864mm
平台长度	Platform Length	4200mm
载重量	Lifting Capacity	(8000LB)3600kg
跑道宽度	Runway Width	475mm
跑道间宽度	Width Between Runway	954mm
包装尺寸	Packing Size	4300x570x725mm
毛重	Gross Weight	780kg

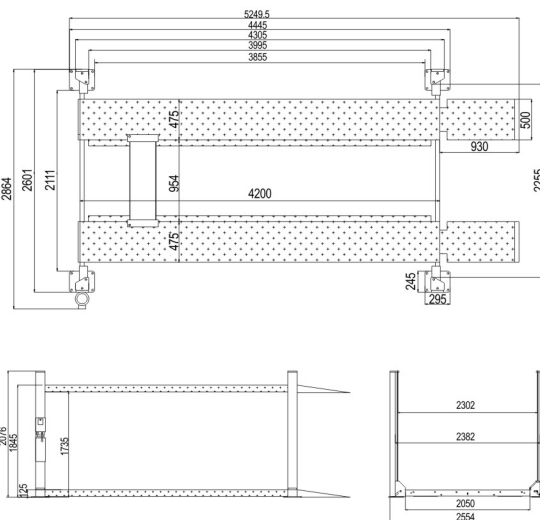

细节说明 Detail



带防爆阀的油缸。
Oil cylinder with explosion-proof valve.



移动架在空载时能方便举升机移动。
People move lift easy when no-load.



钢丝绳断裂保险机构。
For safety mechanism protect quickly declined cause by wire rope breakage.



带有黄色滑条的上坡板可以警示人们并保护地面摩擦。
Up ramp with yellow slider can warn people and protect friction.

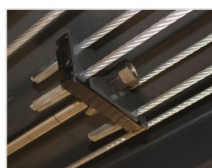

主平台下的钢丝绳连接。
Wire rope connection under main platform.

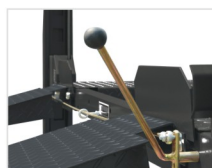

手动保险杆。
Manual safety bar for release.

OPARICK

更多信息请登录 More information please login:
www.dinggaojx.cn www.sxdinggao.en.alibaba.com

绍兴鼎高机械设备有限公司
SHAOXINGDINGGAOMECHANICAL EQUIPMENT CO., LTD.

浙江省绍兴市袍江工业区马山路186号
NO.186 Mashan Road, Paojiang Industrial Zone, Shaoxing, Zhejiang, China
TEL: 0086-0575-84623366 FAX: 0086-0575-84623331
E-mail: lichao@dinggaomechanical.com



www.dinggaojx.cn



www.sxdinggao.en.alibaba.com



PP8S

FOUR POST LIFT

四柱举升机

更多信息请登录
More information please login
www.dinggaojx.cn
www.sxdinggao.en.alibaba.com

产品说明

- 垂直升降停车举升机，是普通车辆停放的理想设备，举升高度1845mm，举升重量8000磅。
- 安装方便，结构紧凑，特殊的移动配件使整个装置在空载时移动方便。
- 手动机械安全机构和钢丝绳断裂保护机构，双重安全机构，更安全。
- 立柱采用高密度滑块，使用寿命长。
- 油管上的防爆节流阀。它能防止油管爆裂而引起的快速下落。
- 平台采用高强度防滑花纹板整体成型。
- 专用刹车块可防止车辆移动。
- 可选配二次举升小车，方便车辆维修。

PRODUCT DESCRIPTION

- Vertical rise and fall parking lift , It is the ideal equipment for the ordinary vehicle parking Lifting height 1845mm, Lifting capacity 8000 pounds.
- Convenient installation, compact structure, the special mobile fitting make the whole device move convenient when no-load.
- Manual mechanical safety organ and wire rope fracture protective mechanism, double safety mechanism, more safety.
- It use high density slide blocks in the columns, Long service life.
- Explosion-proof throttle valve on the oil tube, It can prevent falling fast because of oil tube burst.
- The platform is made of high strength antiskid pattern plate overall molding.
- The special brake block can prevent the vehicles moving.
- Optional rolling jack, convenient for maintenance vehicles.



PP-9

FOUR POST LIFT

四柱举升机



技术参数 Technical parameters

型号	Model	PP-9
长x宽x高	LxWxH	5782.5x3354x2456mm
举升高度	Lifting Height	2150mm
举升时间	Lifting Time	50s
柱间长	Length of Columns	4693mm
总长度	Overall Length	5782.5mm
立柱底板间宽度	Inside Soleplate of Columns Width	2484mm
总宽度	Overall Width	3354mm
平台长度	Platform Length	4990mm
载重量	Lifting Capacity	(9000LB)4000kg
跑道宽度	Runway Width	508mm
跑道间宽度	Width Between Runway	994mm
包装尺寸	Packing Size	5170x570x725mm
毛重	Gross Weight	1120kg

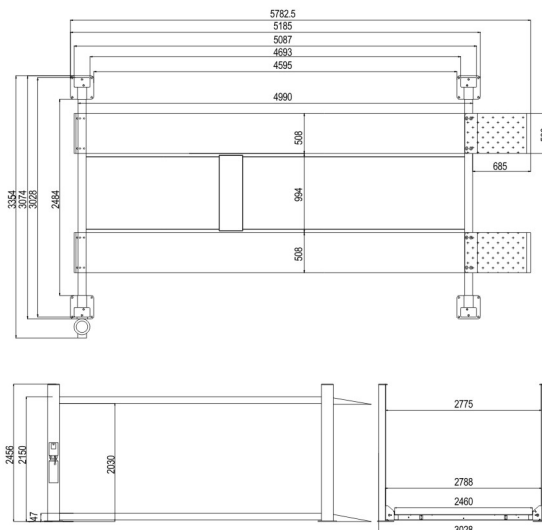

细节说明 Detail



主平台下方的钢丝绳和滑轮。
Cable and pulley under main platform.



移动架空载时可以轻松移动举升机。
Caster kit can make people move lift easy when no-load.



手动保险杆。
Manual safety bar for release.



带有黄色滑条的上坡板可以警示人们并保护地面摩擦。
Up ramp with yellow slider can warn people and protect friction.



钢丝绳断裂保险机构。
Safety mechanism for protect quickly declined cause by wire rope breakage.



尼龙滑块限定保险片位置。
Nylon slide board for limit insurance piece.

OPARICK

更多信息请登录 More information please login:
www.dinggaojx.cn www.sxdinggao.en.alibaba.com

绍兴鼎高机械设备有限公司
SHAOXINGDINGGAOMECHANICAL EQUIPMENT CO., LTD.

浙江省绍兴市袍江工业区马山路186号
NO.186 Mashan Road, Paojiang Industrial Zone, Shaoxing, Zhejiang, China
TEL: 0086-0575-84623366 FAX: 0086-0575-84623331
E-mail: lichao@dinggaomechanical.com



www.dinggaojx.cn



www.sxdinggao.en.alibaba.com



PP-9

FOUR POST LIFT

四柱举升机

更多信息请登录
More information please login
www.dinggaojx.cn
www.sxdinggao.en.alibaba.com

产品说明

- 垂直升降停车举升机，这是一个理想的设备，用于重量在9000磅以内的车辆停放，举升高度2150mm，举升重量9000磅。
- 安装方便，结构紧凑，特殊的移动配件使整个装置在空载时移动方便。
- 手动机械安全机构和钢丝绳断裂保护机构，双重安全机构，更安全。
- 立柱采用高密度滑块，使用寿命长。
- 油管上的防爆节流阀。它能防止油管爆裂而引起的快速下落。
- 平台采用高强度钢板整体成型。
- 专用刹车块可防止车辆移动。
- 可选配二次举升小车，方便车辆维修。

PRODUCT DESCRIPTION

- Vertical rise and fall parking lift, It is the ideal equipment for weight within 9000 pounds vehicle parking. Lifting height 2150mm, Lifting capacity 9000 pounds.
- Convenient installation, compact structure, the special mobile fitting make the whole device move convenient when no-load.
- Manual mechanical safety organ and wire rope fracture protective mechanism, double safety mechanism, more safety.
- It use high density slide blocks in the columns, Long service life.
- Explosion-proof throttle valve on the oil tube, It can prevent falling fast because of oil tube burst.
- The platform is made of high strength antiskid pattern plate overall molding.
- The special brake block can prevent the vehicles moving.
- Optional rolling jack, convenient for maintenance vehicles.



PP-9H

HIGH FOUR-COLUMN PARKING GARAGE

高位四柱停车库



技术参数 Technical parameters

型号	Model	PP-9H
长x宽x高	LxWxH	5786x2809x4322mm
最大举升高度	Max Lifting Height	3800mm
最小高度	Min. Height	147mm
举升距离	Lifting Distance	3680mm
举升时间	Lifting Time	50s
柱间长	Length of Columns	4679mm
总长度	Overall Length	5786mm
立柱底板间宽度	Inside Soleplate of Columns Width	2219mm
总宽度	Overall Width	2809mm
平台长度	Platform Length	4990mm
载重量	Lifting Capacity	(9000LB)4000kg
跑道宽度	Runway Width	508mm
跑道间宽度	Width Between Runway	950-1140mm
包装尺寸1	Packing Size1	5170x570x720mm
包装尺寸2	Packing Size2	4010x200x130mm
毛重1	Gross Weight1	1120kg
毛重2	Gross Weight2	160kg

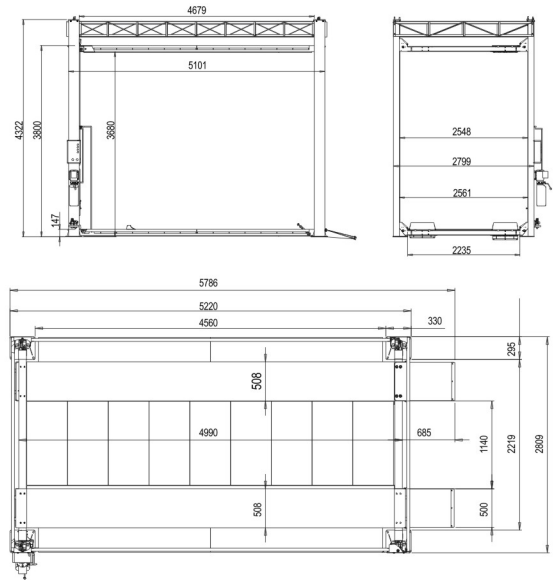

细节说明 Detail



限位开关。
Limit switch.



气缸。
Air cylinder.



主跑道下方的钢丝绳和滑轮。
Wire rope and pulley under main runway.

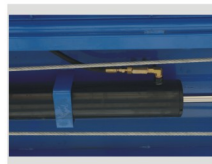

防爆阀。
Oil cylinder with explosion-proof valve.



油水分离器。
Oil-mist separator.



在主跑道下面。
Under main runway.

OPARICK

更多信息请登录 More information please login:
www.dinggaojx.cn www.sxdinggao.en.alibaba.com

绍兴鼎高机械设备有限公司
SHAOXINGDINGGAOMECHANICAL EQUIPMENT CO., LTD.

浙江省绍兴市袍江工业区马山路186号
NO.186 Mashan Road, Paojiang Industrial Zone, Shaoxing, Zhejiang, China
TEL: 0086-0575-84623366 FAX: 0086-0575-84623331
E-mail: lichao@dinggaomechanical.com



www.dinggaojx.cn



www.sxdinggao.en.alibaba.com

OPARICK

SHAOXING DINGGAO MECHANICAL EQUIPMENT CO., LTD.



PP-9H HIGH FOUR-COLUMN PARKING GARAGE

高位四柱停车库

更多信息请登录
More information please login

www.dinggaojx.cn

www.sxdinggao.en.alibaba.com

产品说明

- 垂直升降停车举升机，是商用车和SUV中大型车辆停放的理想设备，举升高度3800mm。举升重量9000磅。
- 安装方便，结构紧凑，特殊的移动配件使整个装置在空载时移动方便。
- 手动机械安全解锁和钢丝绳断裂保护机构，双重安全机构，更安全。
- 立柱采用高密度滑块，使用寿命长。
- 油管上的防爆节流阀。它能防止油管爆裂而快速下落。
- 平台采用高强度钢板整体成型。
- 专用刹车块可防止车辆移动。
- 可二次举升小车，方便车辆维修。

PRODUCT DESCRIPTION

- Vertical rise and fall parking lift, It is the ideal equipment for commercial vehicles and SUV medium and large vehicles parking, Lifting height 3800mm, Lifting capacity 9000 pounds.
- Convenient installation, compact structure, the special mobile fitting make the whole device move convenient when no-load.
- Manual mechanical safety organ and wire rope fracture protective mechanism, double safety mechanism, more safety.
- It use high density slide blocks in the columns, Long service life.
- Explosion-proof throttle valve on the oil tube, It can prevent falling fast because of oil tube burst.
- The platform is made of high strength antiskid pattern plate overall molding.
- The special brake block can prevent the vehicles moving.
- Optional rolling jack, convenient for maintenance vehicles.



专注于四柱举升机设备的研发、制造与销售
FOCUS ON R&D, MANUFACTURING AND SALES OF FOUR-COLUMN LIFTING EQUIPMENT

PP-9F

FOUR POST LIFT

四柱举升机



技术参数 Technical parameters

型号	Model	PP-9F
长x宽x高	LxWxH	5330x2870x2312mm
举升高度	Lifting Height	1914mm on lock
举升时间	Lifting Time	50s
柱间长	Length of Inside Columns	4066mm
总长度	Overall Length	5330mm
立柱底板间宽度	Inside Soleplate of Columns Width	2490mm
总宽度	Overall Width	2870mm
平台长度	Platform Length	4200mm
载重量	Lifting Capacity	(9000LB)4000kg
跑道宽度	Runway Width	475mm
跑道间宽度	Width Between Runway	964mm
包装尺寸	Packing Size	4250x570x730mm
毛重	Gross Weight	890kg

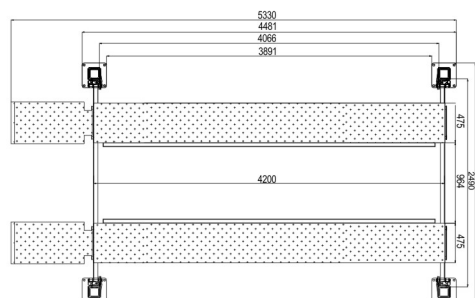
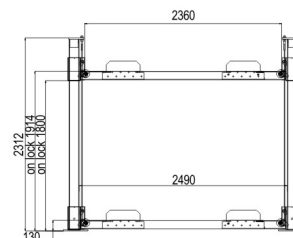

细节说明 Detail



移动架在空载时能方便举升机的移动。

Caster kit can make people move lift easy when no-load.

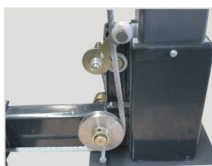

钢丝绳断裂保险机构。

Safety mechanism for protect quickly declined cause by wire rope breakage.



手动保险杆。

Manual safety barfor release.



防爆阀。

Oil cylinder with explosion-proof valve.

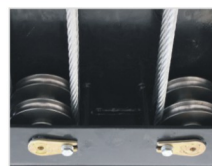

主平台下的钢丝绳及绳轮。

Cable and pulley under main platform.

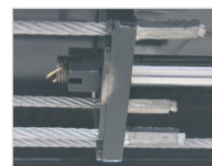

主平台下钢丝绳的连接。

Wire rope connection under main platform.

OPARICK

更多信息请登录 More information please login:
www.dinggaojx.cn www.sxdinggao.en.alibaba.com

绍兴鼎高机械设备有限公司
SHAOXINGDINGGAOMECHANICAL EQUIPMENT CO., LTD.

浙江省绍兴市袍江工业区马山路186号
NO.186 Mashan Road, Paojiang Industrial Zone, Shaoxing, Zhejiang, China
TEL: 0086-0575-84623366 FAX: 0086-0575-84623331
E-mail: lichao@dinggaomechanical.com



www.dinggaojx.cn



www.sxdinggao.en.alibaba.com

OPARICK

SHAOXING DINGGAO MECHANICAL EQUIPMENT CO., LTD.



PP-9F FOUR POST LIFT 四柱举升机

更多信息请登录
More information please login

www.dinggaojx.cn

www.sxdinggao.en.alibaba.com

产品说明

- 梁采用高强度钢冷拔成型。
- 平台采用优质装饰板。
- 手动机械式自复位解锁结构，可根据设计范围内的实际需要调整解锁杆，解锁手柄设有金属软拉链，即使在最高位置也能解锁，安全可靠。
- 每根钢丝绳均设有保险机构，防止钢丝绳断裂时设备坠落。
- 上坡板上的黄色警示条能保护地面不受磨损。
- 立柱采用高强度钢，冷拔成型，每根立柱上都有安全孔，在设计范围内的任何高度都可以锁紧。
- 设备通过125%动载试验和150%静载试验，并通过CE认证。
- 可选螺栓式铁上板或插入式铝合金上板。
- 每台设备在四根立柱底部设有四套快速安装的移动滑轮，在空载情况下，设备只需两人操作，即可在平地上自由移动。

PRODUCT DESCRIPTION

- The beam is formed by cold drawing with high strength steel.
- The platform is made of high-quality decorative plate.
- The manual mechanical self-resetting unlocking structure can adjust the unlocking lever according to the actual needs within the design range, the unlocking handle is equipped with a metal soft zipper that can be unlocked even at the highest position, which is safe and reliable.
- Each wire rope is provided with an insurance mechanism to prevent the equipment from falling when the wire rope is broken.
- Yellow warning strip on the up ramp can protect the ground from wear and tear.
- The columns are made of high strength steel and are formed by cold drawing, each column has safety holes, which can be locked at any height within the design range.
- The equipment passed dynamic load test of 125% and static load test of 150%, and passed ce certification.
- Optional bolt type iron upper plate or plug-in type aluminum alloy upper plate.
- Each equipment is equipped with four sets of fast-installed mobile pulley set at the bottom of the four columns, under the condition of no load, the equipment only needs two people to operate, so that the equipment can move freely on the flat ground.



专注于四柱举升机设备的研发、制造与销售
FOCUS ON R&D, MANUFACTURING AND SALES OF FOUR-COLUMN LIFTING EQUIPMENT

PP-9XLT

FOUR POST LIFT

四柱举升机



技术参数 Technical parameters

型号	Model	PP-9XLT
长x宽x高	LxWxH	5952x2870x2516mm
举升高度	Lifting Height	2119mm on lock
举升时间	Lifting Time	50s
柱间长	Length of Inside Columns	4688mm
总长度	Overall Length	5952mm
立柱底板间宽度	Inside Soleplate of Columns Width	2490mm
总宽度	Overall Width	2870mm
平台长度	Platform Length	4822mm
载重量	Lifting Capacity	(9000LB)4000kg
跑道宽度	Runway Width	475mm
跑道间宽度	Width Between Runway	964mm
包装尺寸	Packing Size	4900x570x730mm
毛重	Gross Weight	1136kg

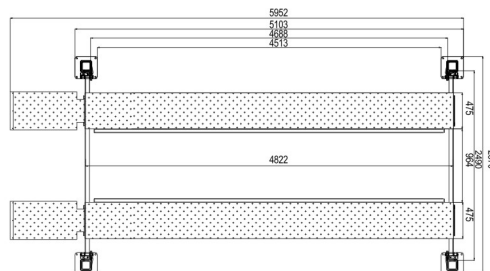
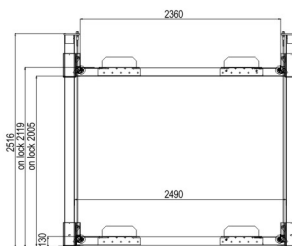

细节说明 Detail



移动架在空载时能方便举升机的移动。
Caster kit can make people move lift easy when no-load.

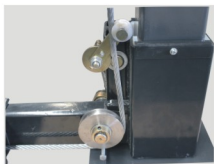

钢丝绳断裂保险机构。
Safety mechanism for protect quickly declined cause by wire rope breakage.



手动保险杆。
Manual safety bar for release.



防爆阀。
Oil cylinder with explosion-proof valve.

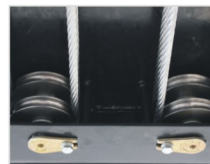

主平台下的钢丝绳及绳轮。
Cable and pulley under main platform.

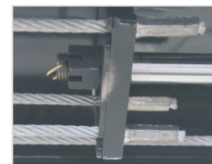

主平台下钢丝绳的连接。
Wire rope connection under main platform.

OPARICK

更多信息请登录 More information please login:
www.dinggaojx.cn www.sxdinggao.en.alibaba.com

绍兴鼎高机械设备有限公司
SHAOXING DINGGAO MECHANICAL EQUIPMENT CO., LTD.

浙江省绍兴市袍江工业区马山路186号
NO.186 Mashan Road, Paojiang Industrial Zone, Shaoxing, Zhejiang, China
TEL: 0086-0575-84623366 FAX: 0086-0575-84623331
E-mail: lichao@dinggaomechanical.com



www.dinggaojx.cn



www.sxdinggao.en.alibaba.com



PP-9XLT

FOUR POST LIFT

四柱举升机

更多信息请登录
More information please login
www.dinggaojx.cn
www.sxdinggao.en.alibaba.com

产品说明

- 梁采用高强度钢冷拔成型。
- 平台采用优质装饰板。
- 手动机械式自复位解锁结构，可根据设计范围内的实际需要调整解锁杆，解锁手柄设有金属软拉链，即使在最高位置也能解锁，安全可靠。
- 每根钢丝绳均设有保险机构，防止钢丝绳断裂时设备坠落。
- 上车板上的黄色警示条能保护地面不受磨损。
- 立柱采用高强度钢，冷拔成型，每根立柱上都有安全孔，在设计范围内的任何高度都可以锁紧。
- 设备通过125%动载试验和150%静载试验，并通过CE认证。
- 可选螺栓式铁上板或插入式铝合金上板。
- 每台设备在四根立柱底部设有四套快速安装的移动滑轮，在空载情况下，设备只需两人操作，即可在平地上自由移动。

PRODUCT DESCRIPTION

- The beam is formed by cold drawing with high strength steel.
- The platform is made of high-quality decorative plate.
- The manual mechanical self-resetting unlocking structure can adjust the unlocking lever according to the actual needs within the design range. The unlocking handle is equipped with a metal soft zipper that can be unlocked even at the highest position, which is safe and reliable.
- Each wire rope is provided with an insurance mechanism to prevent the equipment from falling when the wire rope is broken.
- Yellow warning strip on the car board can protect the ground from wear and tear.
- The columns are made of high strength steel and are formed by cold drawing. Each column has safety holes, which can be locked at any height within the design range.
- The equipment passed dynamic load test of 125% and static load test of 150%, and passed CE certification.
- Optional bolt type iron upper plate or plug-in type aluminum alloy upper plate.
- Each equipment is equipped with four sets of fast-installed mobile pulley set at the bottom of the four columns. Under the condition of no load, the equipment only needs two people to operate, so that the equipment can move freely on the flat ground.





YH-6.3T

OPEN CAR LIFT

More information please login
www.oparck.com
www.sxdinggao.en.alibaba.com

PRODUCT DESCRIPTION

- Beams using high strength rectangular tube.
- Platform overall molding,bearing up to 6.3T.
- Automatic reset type pneumatic safety valves,safety , reliable and high efficiency synchronization.
- Export pneumatic components,long service life.
- Wire rope fracture protective mechanism,can effectively prevent the steel wire rope drop fast when fracture
- Four columns secure level accurate adjustable
- All moving parts are equipped with grease nipple,convenient to fill lubricating oil
- Yellow warning removable parts on the slope,at the same time of warning also protect the ground friction
- Optional slide plate and rolling jack for four-wheel alignment.
- Optional pneumatic or electric rolling jack,Capacity 6.3T(14000 pounds)
- Explosion-proof throttle valve on the oil tube. It can prevent falling fast Caused by oil tube burst.



YH-6.3T

OPEN CAR LIFT



技术参数 Technical parameters

Model	YH-6.3T
LxWxH	7085x3534x2558mm
Max.Lifting Height	1850mm
Min.Height	246mm
Lifting Distance	1750mm
Lifting Time	50s
Length of Columns	5265mm
Overall Length	7085mm
Inside Soleplate of Columns	2166mm
Overall Width	3534mm
Platform Length	5770mm
Lifting Capacity	6.3T(14000 pounds)
Runway Width	508mm
Width Between Runway	1078mm

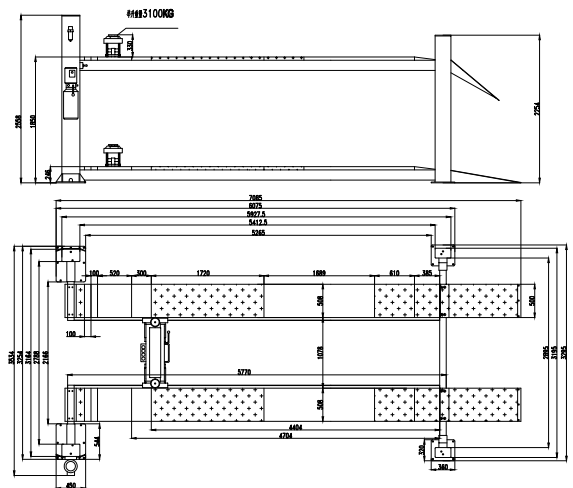

细节说明 Detail



Air cylinder for air release.



Optional pneumatic or electric rolling jack, Optional rouing jaek.
Capacity 3.2T(7000 pounds).



Wire rope $\Phi 12.5$

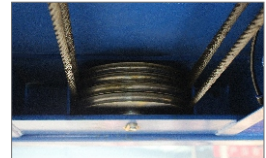

High streng wear-resistant wie ppe.

OPARCK

More information please login:
www.oparck.com www.sxdinggao.en.alibaba.com

SHAOXINGDINGGAOMECHANICAL EQUIPMENT CO., LTD.

NO.186 Mashan Road, Paojiang Industrial Zone, Shaoxing, Zhejiang, China
TEL: 0086-0575-84623366 FAX: 0086-0575-84623331
E-mail: lichao@dinggao.com



www.oparck.com



www.sxdinggao.en.alibaba.com

YH-3.5

FOUR POST LIFT

四柱举升机



技术参数 Technical parameters

型号	Model	YH-3.5T
长x宽x高	LxWxH	5127.5x3555x2216mm
举升高度	Lifting Height	1950mm
举升时间	Lifting Time	50s
柱间长	Length of Columns	4030mm
总长度	Overall Length	5127.5mm
立柱底板间宽度	Inside Soleplate of Columns Width	2785mm
总宽度	Overall Width	3555mm
平台长度	Platform Length	4300mm
载重量	Lifting Capacity	3500kg
跑道宽度	Runway Width	480mm
跑道间宽度	Width Between Runway	1000mm
包装尺寸	Packing Size	4400x570x800mm
毛重	Gross Weight	960kg

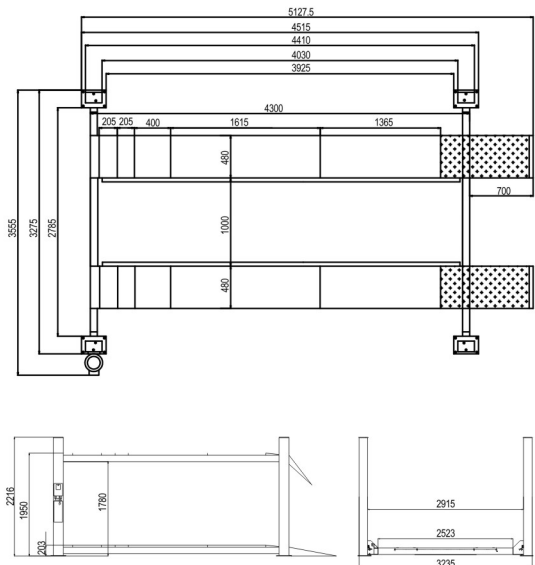

细节说明 Detail



带滑块的上坡道可以保护摩擦。
Up ramp with slider can protect friction.



跑道下液压缸，带防爆阀。
Hydraulic cylinder under runway with explosion-proof valve.



主跑道下钢丝绳和滑轮的结构。
Structure of cable and pulley under main runway.

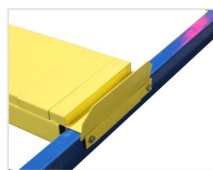

活动板可适用于不同尺寸的转角盘。
Active plate can fit for different size turntable.



用于四轮定位的侧滑板。
Slide plate for wheel alignment.



可选配二次举升小车。
Optional rolling jack.

OPARICK

更多信息请登录 More information please login:
www.dinggaojx.cn www.sxdinggao.en.alibaba.com

绍兴鼎高机械设备有限公司
SHAOXINGDINGGAOMECHANICAL EQUIPMENT CO., LTD.

浙江省绍兴市袍江工业区马山路186号
NO.186 Mashan Road, Paojiang Industrial Zone, Shaoxing, Zhejiang, China
TEL: 0086-0575-84623366 FAX: 0086-0575-84623331
E-mail: lichao@dinggaomechanical.com



www.dinggaojx.cn



www.sxdinggao.en.alibaba.com



YH-3.5

FOUR POST LIFT

四柱举升机

更多信息请登录
More information please login
www.dinggaojx.cn
www.sxdinggao.en.alibaba.com

产品说明

- 梁采用高强度矩形管，外形美观。
- 平台整体成型，承重3.5吨。
- 自动复位式气动保险阀。安全、可靠、高效同步。
- 带压力表的标准油水分离器。
- 钢丝绳断裂保护机构能有效防止钢丝绳断裂时快速下落。
- 可选配侧滑板和二次举升小车，用于四轮定位。
- 可选配二次举升小车，举升重量4500磅(2吨)，举升高度330mm，立柱上有软管支架。
- 黄色警示可在斜坡上移动部分，同时警示也保护地面摩擦。
- 四柱安全水平精确可调。
- 油路上设有节流阀一套。
- 所有运动部件均配有黄油嘴，便于加注润滑油。
- 出口型气动安全元件使用寿命长，同步效率高。

PRODUCT DESCRIPTION

- Beam using high strength rectangular tube with beautiful appearance.
- Platform overall molding, bearing up to 3.5 tons .
- Automatic rest type pneumatic safety valve .Safety,reliable and high efficiency synchronization.
- Standard oil-water separator with pressure gauge.
- The wire rope fracture protective mechanism can effectively prevent the steel wire rope drop fast when fracture.
- Optional slide plate and rolling jack for four-wheel alignment.
- Optional hydraulic rolling jack, bearing 4500 pounds(2 tons),lifting height 330mm, and there is hose bracket on the column.
- Yellow warning removable parts on the slope, at the same time of warning also protect the ground friction.
- Four columns secure level accurate adjustable.
- There is a throttle valve on the channel for oiling.
- All moving parts are equipped with grease nipple ,convenient to fill lubricating oil.
- Export-type pneumatic safety components have long service life and high synchronization efficiency.



YH-4.0B

FOUR POST LIFT

四柱举升机



技术参数 Technical parameters

型号	Model	YH-4.0B
长x宽x高	LxWxH	5645x3436x2222mm
举升高度	Lifting Height	1850mm
举升时间	Lifting Time	50s
柱间长	Length of Columns	4290mm
总长度	Overall Length	5645mm
立柱底板间宽度	Inside Soleplate of Columns Width	2546mm
总宽度	Overall Width	3436mm
平台长度	Platform Length	4600mm
载重量	Lifting Capacity	4000kg
跑道宽度	Runway Width	508mm
跑道间宽度	Width Between Runway	1000mm-1100mm
包装尺寸	Packing Size	4750x570x725mm
毛重	Gross Weight	1140kg

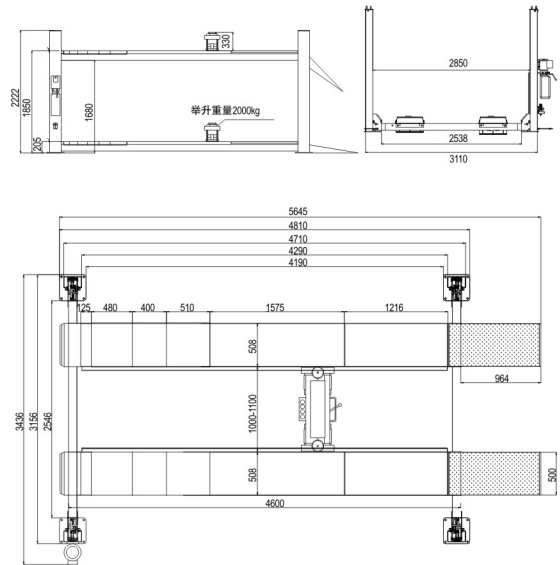

细节说明 Detail

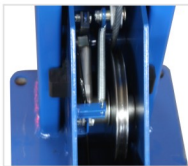

气动保险装置。
Air cylinder for air release.



带防爆阀的油缸。
Oil cylinder with explosion-proof valve.



立柱内保险片。
Insurance piece in side column.



带有黄色滑条的上坡板可以警示人们并保护与地面摩擦。
Up ramp with yellow slider can warn people and protect friction.

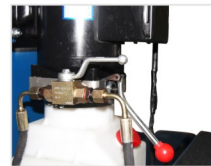

阀门控制平台和二次举升小车。
The valve control platform and rolling jack.



可选二次举升小车。
Optional rolling jack.

OPARICK

更多信息请登录 More information please login:
www.dinggaojx.cn www.sxdinggao.en.alibaba.com

绍兴鼎高机械设备有限公司
SHAOXINGDINGGAOMECHANICAL EQUIPMENT CO., LTD.

浙江省绍兴市袍江工业区马山路186号
NO.186 Mashan Road, Paojiang Industrial Zone, Shaoxing, Zhejiang, China
TEL: 0086-0575-84623366 FAX: 0086-0575-84623331
E-mail: lichao@dinggaomechanical.com



www.dinggaojx.cn



www.sxdinggao.en.alibaba.com



YH-4.0B

FOUR POST LIFT

四柱举升机

更多信息请登录
More information please login

www.dinggaojx.cn
www.sxdinggao.en.alibaba.com

产品说明

- 梁采用高强度矩形管，外形美观。
- 平台整体成型，承重可达4吨。
- 手动机械复位保险机构。安全、可靠、高效同步。
- 钢丝绳断裂保护机构能有效防止钢丝绳断裂时快速下落。
- 可选配侧滑板和二次举升小车，用于四轮定位。
- 可选配二次举升小车，举升重量4500磅(2吨),举升高度330mm，立柱上有软管支架。
- 上坡板黄色警示条既起到警示作用，同时又保护与地面的摩擦。
- 四柱安全水平精确可调。
- 油路上设有节流阀。
- 各转动部件均配有黄油嘴，方便加注润滑油效率高。

PRODUCT DESCRIPTION

- Beam using high strength rectangular tube with beautiful appearance.
- Platform overall molding, bearing up to 4 tons .
- Manual mechanical reset insurance mechanism .Safety, reliable and high efficiency synchronization.
- The wire rope fracture protective mechanism can effectively prevent the steel wire rope drop fast when fracture.
- Optional slide plate and rolling jack for four-wheel alignment.
- Optional hydraulic rolling jack, bearing 4500 pounds(2 tons),lifting height 330mm, and there is hose bracket on the column.
- Yellow warning removable parts on the up ramp, at the same time of warning also protect the ground friction.
- Four columns secure level accurate adjustable.
- There is a throttle valve on the channel for oiling.
- All moving parts are equipped with grease nipple ,convenient to fill lubricating oil efficiency.



专注于四柱举升机设备的研发、制造与销售
FOCUS ON R&D, MANUFACTURING AND SALES OF FOUR-COLUMN LIFTING EQUIPMENT



YH-4.0D

FOUR POST LIFT

More information please login
www.dinggaojx.cn
www.sxdinggao.en.alibaba.com

PRODUCT DESCRIPTION

- Four-post scissor lift are ideal repair equipment for 4S stores.
- Platform overall forming bearing up to 4tons, and the maximum lifting height is 1900 mm.
- Pneumatic insurance mechanism and wire rope breakage insurance mechanism, double insurance, safer.
- Explosion-proof valves on the oil road can effectively protect the falling caused by tubing burst.
- Four columns secure level accurate adjustable.
- All moving parts are equipped with grease nipple ,convenient filling lubricating oil.
- Control the lifting of the main engine and auxiliary engine through the conversion valve.



YH-4.0D

FOUR POST LIFT



Technical parameters

Model	YH-4.0D
LxWxH	5958x3436x2222mm
Lifting Height	1900mm
Small Scissors Lifting Height	380mm
Lifting Time	50s
Length of Columns	4390mm
Overall Length	5958mm
Inside Soleplate of Columns Width	2546mm
Overall Width	3436mm
Platform Length	4700mm
Lifting Capacity	(9000lbs)4000kg
Small Scissor Lifting Capacity	3000kg
Packing Size	5250x600x840mm
Gross Weight	1600kg

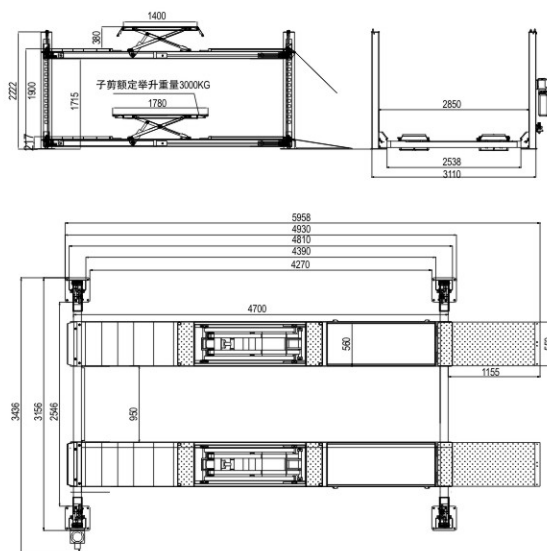

Detail

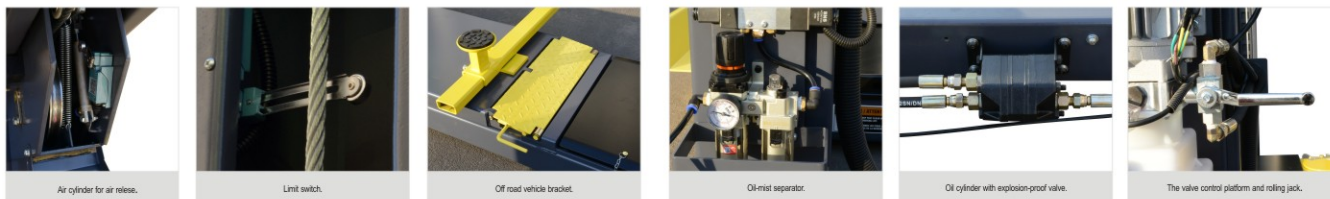

OPARICK

More information please login:
www.dinggaojx.cn www.sxdinggao.en.alibaba.com

SHAOXINGDINGGAOMECHANICAL EQUIPMENT CO., LTD.

NO186 Mashan Road, Paojiang Industrial Zone, Shaoxing Zhejiang, China
 TEL: (0086)-0575-84623366 FAX: (0086)-0575-84623331
 E-mail: lichao_dinggao@mechanical.com



www.dinggaojx.cn



www.sxdinggao.en.alibaba.com

YH-4.5BWL

FOUR POST LIFT

四柱举升机



技术参数 Technical parameters

型号	Model	YH-4.5BWL
长x宽x高	LxWxH	5835x3600x2222mm
举升高度	Lifting Height	1850mm
举升时间	Lifting Time	50s
柱间长	Length of Columns	4680mm
总长	Overall Length	5835mm
立柱底板间宽度	Inside Soleplate of Columns Width	2710mm
柱内底板	Overall Width	3600mm
平台长度	Platform Length	4990mm
载重量	Lifting Capacity	4500kg
跑道宽度	Runway Width	508mm
跑道间宽度	Width Between Runway	1000-1100mm
包装尺寸	Packing Size	5250x570x725mm
毛重	Gross Weight	1300kg

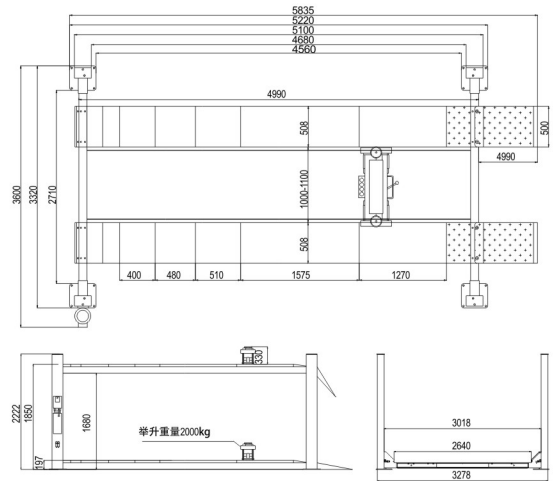

细节说明 Detail

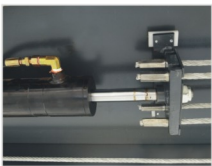

带防爆阀的油缸。
Oil cylinder with explosion-proof valve.

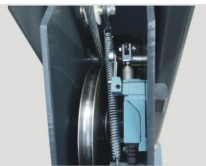

安全结构。
Safety structure.

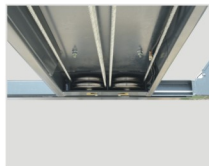

主跑道下方的电缆和滑轮。
Cable and pulley under main runway.



下限和油水分离器。
Down limit and oil-mist separator.

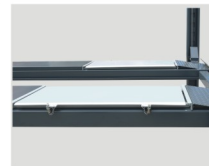

用于四轮定位的侧滑板。
Slide plate for wheel alignment.



滑块可以警示人们并保护地面摩擦。
Slider can warn people and protect friction.

OPARICK

更多信息请登录 More information please login:
www.dinggaojx.cn www.sxdinggao.en.alibaba.com

绍兴鼎高机械设备有限公司
SHAOXINGDINGGAOMECHANICAL EQUIPMENT CO., LTD.

浙江省绍兴市袍江工业区马山路186号
NO.186 Mashan Road, Paojiang Industrial Zone, Shaoxing, Zhejiang, China
TEL: 0086-0575-84623366 FAX: 0086-0575-84623331
E-mail: lichao@dinggaomechanical.com



www.dinggaojx.cn



www.sxdinggao.en.alibaba.com



YH-4.5BWL

FOUR POST LIFT

四柱举升机

更多信息请登录
More information please login
www.dinggaojx.cn
www.sxdinggao.en.alibaba.com

产品说明

- 使用高强度H型钢的梁。
- 平台整体成型，承重4.5吨。
- 手动复位锁紧机构，使用寿命长，安全可靠，保险杆可调。
- 钢丝绳断裂保护系统，能有效防止钢丝绳断裂时快速下降。
- 上坡板黄色警示条起到警示同时保护与地面的摩擦。
- 可选液压二次提升小车，承重4500磅，举升高度330mm，立柱上有小车软管支架。
- 油路上设有节流阀。
- 四柱安全水平精确可调。
- 所有转动部件均配有黄油嘴，方便加注润滑油。

PRODUCT DESCRIPTION

- Beams using high strength H steel.
- Platform overall forming bearing up to 4.5 tons.
- Manual reset locking mechanism, long service life, safety and reliable, Adjustable bumper.
- Wire rope fracture protective system, can effectively prevent the steel wire rope drop fast when fracture.
- Yellow warning removable parts on the up ramp, at the same time of warning also protect the ground friction.
- Optional hydraulic secondary lifting trolley, bearing 4500 pounds, hoisting height 330mm, and has a trolley hose bracket on the column.
- There is throttle valve on the channel for oiling.
- Four columns secure level accurate adjustable.
- All moving parts are equipped with grease nipple, convenient filling lubricating oil.



专注于四柱举升机设备的研发、制造与销售
FOCUS ON R&D, MANUFACTURING AND SALES OF FOUR-COLUMN LIFTING EQUIPMENT

YH-5.5

FOUR POST LIFT

四柱举升机



技术参数 Technical parameters

型号	Model	YH-5.5
长x宽x高	LxWxH	6430x3595x2254mm
举升高度	Lifting Height	1850mm
举升时间	Lifting Time	50s
柱间长	Length of Columns	4820mm
总长度	Overall Length	6430mm
立柱底板间宽度	Inside Soleplate of Columns Width	2655mm
总宽度	Overall Width	3595mm
平台长度	Platform Length	5160mm
载重量	Lifting Capacity	5500kg
跑道宽度	Runway Width	508mm
跑道间宽度	Width Between Runway	1078mm
包装尺寸	Packing Size	5380x560x800mm
毛重	Gross Weight	1680kg

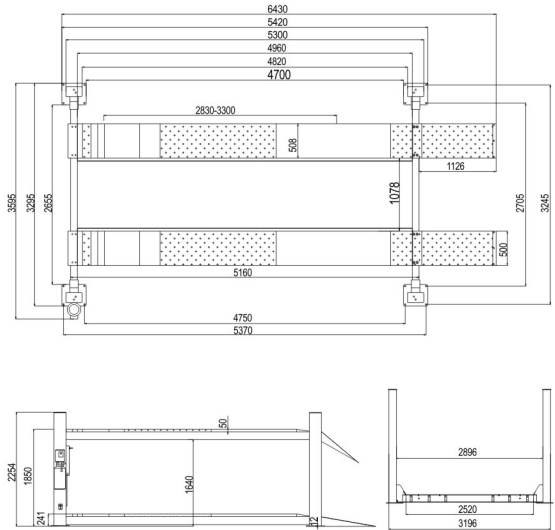

细节说明 Detail

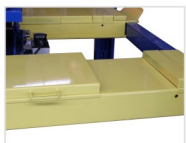

活动板可适用于不同尺寸的转角盘。

Active plate can fit for different size turntable.



气动解锁装置。

Air cylinder for air release.



尼龙滑块限制保险片位置。

Nylon slide board for limit insurance piece.



主跑道下钢丝绳和滑轮的结构。

Structure of cable and pulley under main runway.



用于四轮定位的滑板。

Slide plate for wheel alignment.



可选配二次举升小车。

Optional rolling jack.



带防爆阀的油缸。

Oil cylinder with explosion-proof valve.

OPARICK

更多信息请登录 More information please login:
www.dinggaojx.cn www.sxdinggao.en.alibaba.com

绍兴鼎高机械设备有限公司
 SHAOXINGDINGGAOMECHANICAL EQUIPMENT CO., LTD.

浙江省绍兴市袍江工业区马山路186号
 NO.186 Mashan Road, Paojiang Industrial Zone, Shaoxing, Zhejiang, China
 TEL: 0086-0575-84623366 FAX: 0086-0575-84623331
 E-mail: lichao@dinggaomechanical.com



www.dinggaojx.cn



www.sxdinggao.en.alibaba.com



YH-5.5

FOUR POST LIFT

四柱举升机

更多信息请登录
More information please login
www.dinggaojx.cn
www.sxdinggao.en.alibaba.com

产品说明

- 使用高强度H型钢的梁。
- 平台整体成型轴承高达5.5T。
- 带油水分离器。
- 钢丝绳断裂保护系统能有效防止钢丝绳断裂时下降速度。
- 可选配侧滑板，用于四轮定位。
- 可选的液压滚动千斤顶，可支持高达4500lb和330mm的提升高度。
- 黄色警告-斜坡上的可拆卸部件，在起到警示的同时可保护地面磨损。
- 四柱安全水平精确可调。
- 油路上设有节流阀。
- 出口气动锁定组件，长使用寿命，高效同步。

PRODUCT DESCRIPTION

- Beam using high strength H steel.
- Platform overall forming bearing up to 5.5T.
- With oil-water separator.
- Wire rope fracture protective system can effectively prevent the steel wire rope fast when fracture.
- Optional all cover slip plate, facilitate the vehicle four-wheel alignment accurately.
- Optional hydraulic rolling jack, can support up to 4500lb and the lifting height 330mm.
- Yellow warning removable parts on the slope, at the same time of warning also protect the ground friction.
- Four columns secure level accurate adjustable.
- There is throttle valve on the channel for oiling.
- Export pneumatic locking components, long service lift, high efficiency synchronization.



YH-6.5

FOUR POST LIFT

四柱举升机



技术参数 Technical parameters

型号	Model	YH-6.5
长x宽x高	LxWxH	7040x3575x2254mm
举升高度	Lifting Height	1850mm
举升时间	Lifting Time	50s
柱间长	Length of Columns	5430mm
总长度	Overall Length	7040mm
立柱底板间宽度	Inside Soleplate of Columns Width	2655mm
总宽度	Overall Width	3575mm
平台长度	Platform Length	5770mm
载重量	Lifting Capacity	6500kg
跑道宽度	Runway Width	508mm
跑道间宽度	Width Between Runway	1078-1178mm
包装尺寸	Packing Size	6010x570x900mm
毛重	Gross Weight	1800kg

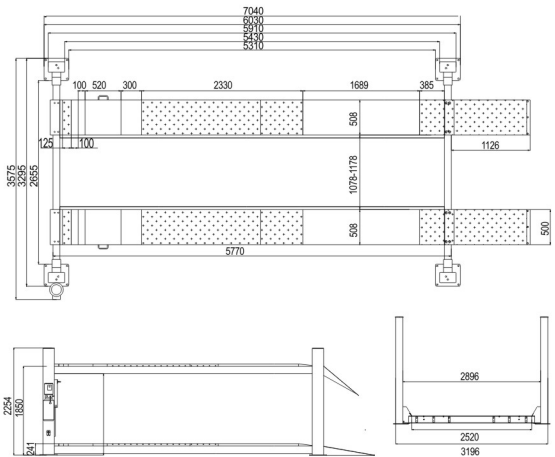

细节说明 Detail

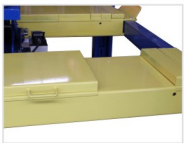

活动板可适用于不同尺寸的转角盘。
Active plate can fit for different size turntable.



气动解锁气缸。
Air cylinder for air release.



尼龙滑块限定保险片位置。
Nylon slide board for limit insurance piece.



主跑道下电缆和滑轮的结构。
Structure of cable and pulley under main runway.



用于四轮定位的滑板。
Slide plate for wheel alignment.



可选配二次举升小车。
Optional rolling jack.



带防爆阀的油缸。
Oil cylinder with explosion-proof valve.

OPARICK

更多信息请登录 More information please login:
www.dinggaojx.cn www.sxdinggao.en.alibaba.com

绍兴鼎高机械设备有限公司
SHAOXINGDINGGAOMECHANICAL EQUIPMENT CO., LTD.

浙江省绍兴市袍江工业区马山路186号
NO.186 Mashan Road, Paojiang Industrial Zone, Shaoxing, Zhejiang, China
TEL: 0086-0575-84623366 FAX: 0086-0575-84623331
E-mail: lichao@dinggaomechanical.com



www.dinggaojx.cn



www.sxdinggao.en.alibaba.com



YH-6.5

FOUR POST LIFT

四柱举升机

更多信息请登录
More information please login

www.dinggaojx.cn
www.sxdinggao.en.alibaba.com

产品说明

- 梁采用高强度矩形管。
- 平台整体成型，承重可达6.5吨。
- 手动机械复位保险机构。安全、可靠、高效同步。
- 出口型气动安全元件使用寿命长，同步效率高。
- 带压力表的标准油水分离器。
- 钢丝绳断裂保护机构能有效防止钢丝绳断裂时快速下落。
- 可选配侧滑板 and 二次举升小车，用于四轮定位。
- 可选配二次举升小车，承载7000磅(3.2吨),方便调整底盘和拆卸轮胎。
- 黄色警示可在斜坡上移动部分，同时警示也保护地面摩擦。
- 四柱安全水平精确可调。
- 所有运动部件均配有黄油嘴，便于加注润滑油。
- 适用于4s、中高档汽车维修公司。

PRODUCT DESCRIPTION

- Beam using high strength rectangular tube.
- Platform overall molding, bearing up to 6.5 tons .
- Manual mechanical reset insurance mechanism .Safety, reliable and high efficiency synchronization.
- Export-type pneumatic safety components have long service life and high synchronization efficiency.
- Standard oil-water separator with pressure gauge.
- The wire rope fracture protective mechanism can effectively prevent the steel wire rope drop fast when fracture.
- Optional slide plate and rolling jack for four-wheel alignment.
- Optional hydraulic rolling jack, bearing 7000 pounds(3.2tons), convenient adjustment of the chassis and disassembling tyres.
- Yellow warning removable parts on the slope, at the same time of warning also protect the ground friction.
- Four columns secure level accurate adjustable.
- All moving parts are equipped with grease nipple , convenient to fill lubricating oil.
- Suitable for 4s, middle and top grade auto maintenance companies.



专注于四柱举升机设备的研发、制造与销售
FOCUS ON R&D, MANUFACTURING AND SALES OF FOUR-COLUMN LIFTING EQUIPMENT

OPARICK

SHAOXING DINGGAO MECHANICAL EQUIPMENT CO., LTD.



RJ3500

MANUAL ROLLING JACK

手动小车

更多信息请登录
More information please login

www.dinggaojx.cn
www.sxdinggao.en.alibaba.com

技术参数 Technical parameters

型号	Model	RJ3500
包装尺寸	Packing Size	950X600X260MM
毛重	Gross Weight	125KG
承重	Capacity	1500KG

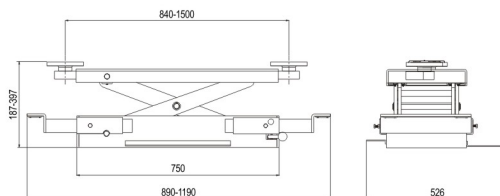

专注于四柱举升机设备的研发、制造与销售
FOCUS ON R&D, MANUFACTURING AND SALES OF FOUR-COLUMN LIFTING EQUIPMENT



RJ4500

MANUAL ROLLING JACK

手动小车

更多信息请登录
More information please login
www.dinggaojx.cn
www.sxdinggao.en.alibaba.com

技术参数 Technical parameters

型号	Model	RJ4500
包装尺寸	Packing Size	950X600X280MM
毛重	Gross Weight	2000KG
承重	Capacity	151KG

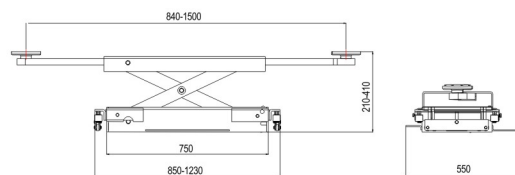



RJQ4500

PNEUMATIC ROLLING JACK

气动小车

更多信息请登录
More information please login
www.dinggaojx.cn
www.sxdinggao.en.alibaba.com

技术参数 Technical parameters

型号	Model	RJQ4500
包装尺寸	Packing Size	950x600x280MM
毛重	Gross Weight	151KG
承重	Capacity	2000KG

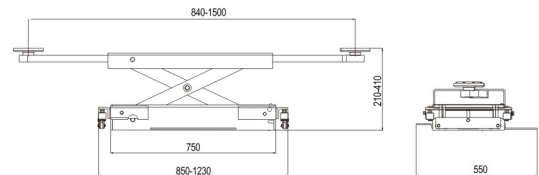



RJQ7000

PNEUMATIC ROLLING JACK

气动小车

更多信息请登录
More information please login
www.dinggaojx.cn
www.sxdinggao.en.alibaba.com

技术参数 Technical parameters

型号	Model	RJQ7000
包装尺寸	Packing Size	1030x470x340mm
毛重	Gross Weight	164kg
承重	Capacity	3000kg

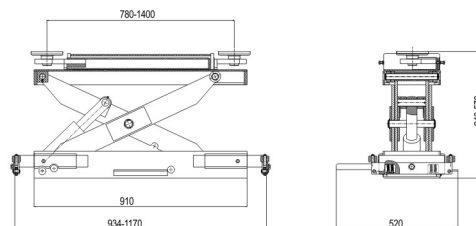

RJ13500

PNEUMATIC JACK

6吨气动小车

技术参数 Technical parameters

型号	Model	RJ13500
包装尺寸	Packing Size	1400 × 850 × 430MM
净重	Net weight	297.15KG
载重量	Capacity	6T

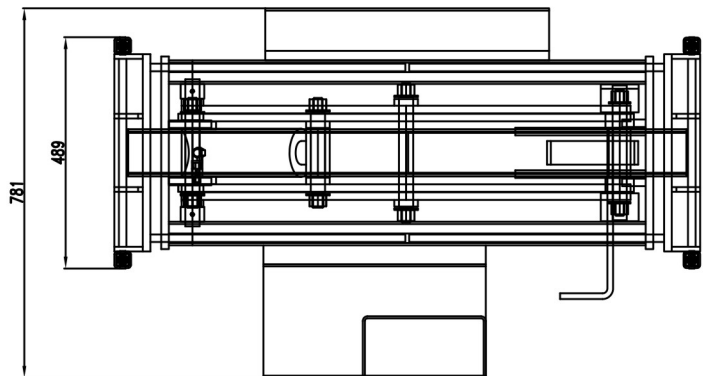
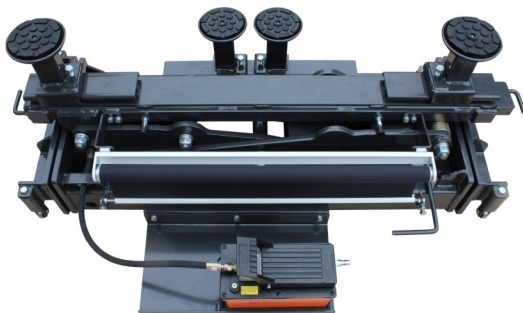
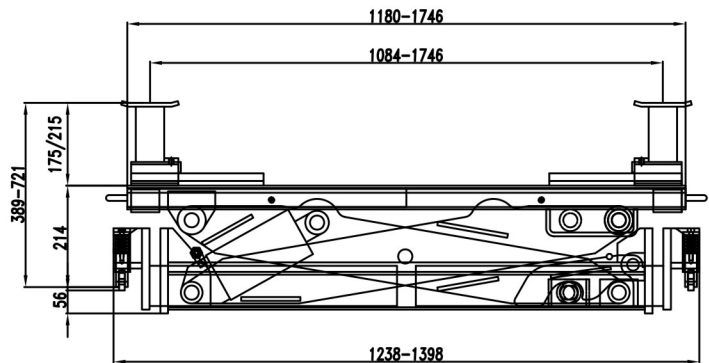

OPARCK

更多信息请登录 More information please login:
www.oparck.com www.sxdinggao.en.alibaba.com

绍兴鼎高机械设备有限公司
SHAOXINGDINGGAOMECHANICAL EQUIPMENT CO., LTD.

浙江省绍兴市袍江工业区马山路186号
NO.186 Mashan Road, Paojiang Industrial Zone, Shaoxing, Zhejiang, China
TEL: 0086-0575-84623366 FAX: 0086-0575-84623331
E-mail: lichao@dinggao.com



www.oparck.com



www.sxdinggao.en.alibaba.com



YH-9A

TWO POST LIFT

双柱举升机

产品说明

- 双柱举升机，外型美观，节省场地空间，检修与修车用。
- 电机带动油泵驱动液压油缸，钢丝绳传动，工作环境安静。
- 机械安全锁，可任意锁定在设计范围内高度进行作业，安全可靠。
- 双边手动解锁，方便快捷，链条断裂保险装置。
- 经过严格的CE认证测试，120%的动态装载测试，150%的静态装载测试。

PRODUCT DESCRIPTION

- Two post car lift, beautiful appearance, save space. Maintenance and repair.
- Motor driven oil pump driven hydraulic cylinder, wire rope drive, quiet working environment.
- Mechanical safety lock, can be arbitrarily locked in the design range of height for operation, safe and reliable.
- Bilateral manual unlocking, convenient and fast, safety device for chain break.
- After strict CE certification test, 120% dynamic load test, 150% static load test.



YH-9A

TWO POST LIFT

双柱举升机



技术参数 Technical parameters

举升重量	Lifting capacity	4000kg
安装宽度	Mount width	3369mm
立柱高度	Height of post	2774mm
举升高度	Lifting height	1833mm
立柱间距	Width between post	2795mm
最低高度	Min height	105mm
上升时间	Lifting time	<50s
下降时间	Lowering time	<40s
电机功率	Motor power	2.2kw
电压	Power supply	220v/380v

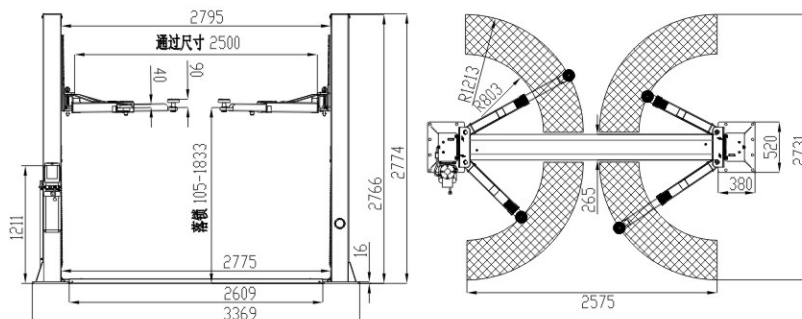

细节说明 Detail



手动双边解锁, 下置式解锁钢丝
Manual two sides lock
release Underlying release cable



高精度5度托臂斜齿
High-precision 5 degrees
arm lock

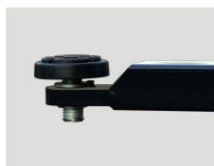

二节螺旋举升托垫
2-stage Screw-up pads



车门保护橡胶
Door Opening
Protection Rubber

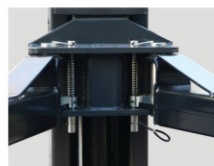

加强型滑台内置锁
Strengthen carriage
Inner arm lock

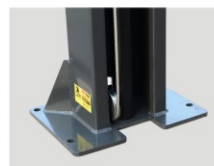

节流阀
Parachute valve

OPARICK

绍兴鼎高机械设备有限公司
SHAOXINGDINGGAOMECHANICAL EQUIPMENT CO., LTD.

浙江省绍兴市袍江工业区马山路186号
NO.186 Mashan Road, Paojiang Industrial Zone, Shaoxing, Zhejiang, China
TEL: 0086-0575-84623366 FAX: 0086-0575-84623331
E-mail: lichao@dinggaomechanical.com



www.shyinghaojx.com



www.sxdinggao.en.alibaba.com

更多信息请登录 More information please login:
www.shyinghaojx.com www.sxdinggao.en.alibaba.com



YH-9B

TWO POST LIFT

双柱举升机

产品说明

- 双柱举升机，外型美观，节省场地空间，检修与修车用。
- 电机带动油泵驱动液压油缸，钢丝绳传动，工作环境安静。
- 机械安全锁，可任意锁定在设计范围内高度进行作业，安全可靠。
- 双边手动解锁，方便快捷，链条断裂保险装置。
- 经过严格的CE认证测试，120%的动态装载测试，150%的静态装载测试。

PRODUCT DESCRIPTION

- Two post car lift, beautiful appearance, save space. Maintenance and repair.
- Motor driven oil pump driven hydraulic cylinder, wire rope drive, quiet working environment.
- Mechanical safety lock, can be arbitrarily locked in the design range of height for operation, safe and reliable.
- Bilateral manual unlocking, convenient and fast, safety device for chain break.
- After strict CE certification test, 120% dynamic load test, 150% static load test.



YH-9B

TWO POST LIFT

双柱举升机



技术参数 Technical parameters

举升重量	Lifting capacity	4000kg
安装宽度	Mount width	3369mm
立柱高度	Height of post	3686mm
举升高度	Lifting height	1833mm
立柱间距	Width between post	2765mm
最低高度	Min height	105mm
上升时间	Lifting time	<50s
下降时间	Lowering time	<40s
电机功率	Motor power	2.2kw
电压	Power supply	220v/380v

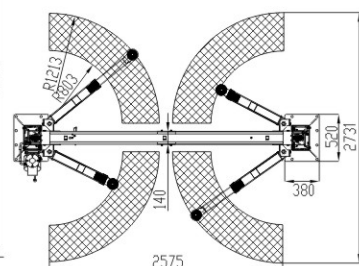
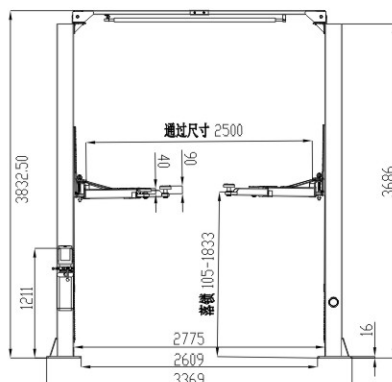

细节说明 Detail



手动双边解锁, 下置式解锁钢丝
Manual two sides lock
release Underlying release cable



高精度5度托臂斜齿
High-precision 5 degrees
arm lock



二节螺旋举升托垫
2-stage Screw-up pads



车门保护橡胶
Door Opening
Protection Rubber

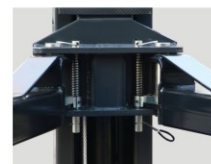

加强型滑台内置锁
Strengthen carriage
Inner arm lock

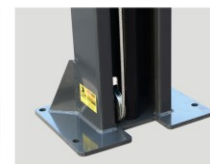

节流阀
Parachute valve

OPARICK

更多信息请登录 More information please login:
www.shyinghaojx.com www.sxdinggao.en.alibaba.com

绍兴鼎高机械设备有限公司
SHAOXINGDINGGAOMECHANICAL EQUIPMENT CO., LTD.

浙江省绍兴市袍江工业区马山路186号
NO.186 Mashan Road, Paojiang Industrial Zone, Shaoxing, Zhejiang, China
TEL: 0086-0575-84623366 FAX: 0086-0575-84623331
E-mail: lichao@dinggaomechanical.com



www.shyinghaojx.com



www.sxdinggao.en.alibaba.com



YH-9C

TWO POST LIFT

双柱举升机

产品说明

- 双柱举升机，外型美观，节省场地空间，检修与修车用。
- 电机带动油泵驱动液压油缸，钢丝绳传动，工作环境安静。
- 机械安全锁，可任意锁定在设计范围内高度进行作业，安全可靠。
- 双边手动解锁，方便快捷，链条断裂保险装置。
- 经过严格的CE认证测试，120%的动态装载测试，150%的静态装载测试。

PRODUCT DESCRIPTION

- Two post car lift, beautiful appearance, save space. Maintenance and repair.
- Motor driven oil pump driven hydraulic cylinder, wire rope drive, quiet working environment.
- Mechanical safety lock, can be arbitrarily locked in the design range of height for operation, safe and reliable.
- Bilateral manual unlocking, convenient and fast, safety device for chain break.
- After strict CE certification test, 120% dynamic load test, 150% static load test.



YH-9C

TWO POST LIFT

双柱举升机



技术参数 Technical parameters

举升重量	Lifting capacity	4000kg
安装宽度	Mount width	3369mm
立柱高度	Height of post	3686mm
举升高度	Lifting height	1833mm
立柱间距	Width between post	2765mm
最低高度	Min height	105mm
上升时间	Lifting time	<50s
下降时间	Lowering time	<40s
电机功率	Motor power	2.2kw
电压	Power supply	220v/380v

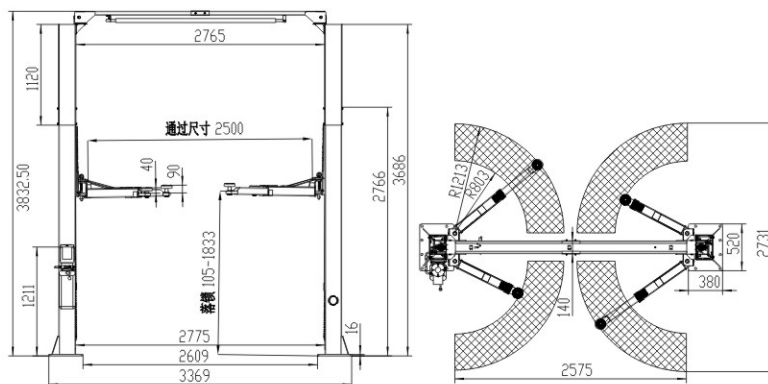

细节说明 Detail



手动双边解锁, 下置式解锁钢丝
Manual two sides lock
release Underlying release cable



高精度5度托臂斜齿
High-precision 5 degrees
arm lock

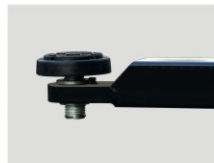

二节螺旋举升托垫
2-stage Screw-up pads

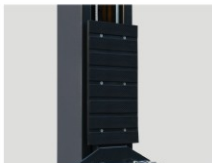

车门保护橡胶
Door Opening
Protection Rubber



加强型滑台内置锁
Strengthen carriage
Inner arm lock

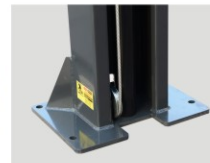

节流阀
Parachute valve

OPARICK

绍兴鼎高机械设备有限公司
SHAOXINGDINGGAOMECHANICAL EQUIPMENT CO., LTD.

浙江省绍兴市袍江工业区马山路186号
NO.186 Mashan Road, Paojiang Industrial Zone, Shaoxing, Zhejiang, China
TEL: 0086-0575-84623366 FAX: 0086-0575-84623331
E-mail: lichao@dinggaomechanical.com



www.shyinghaojx.com



www.sxdinggao.en.alibaba.com

更多信息请登录 More information please login:
www.shyinghaojx.com www.sxdinggao.en.alibaba.com



OPK-MP500

MOTORCYCLE LIFT

摩托车举升机

更多信息请登录
More information please login
www.oparck.com
www.sxdinggao.en.alibaba.com

PRODUCT DESCRIPTION

- Pneumatic foot step control
- Side extensions-optional
- Front table extension-optional
- Fast lifting
- Pneumatic lifting cylinder
- Adjustable front wheel vise
- Rear wheel repair pit reverse

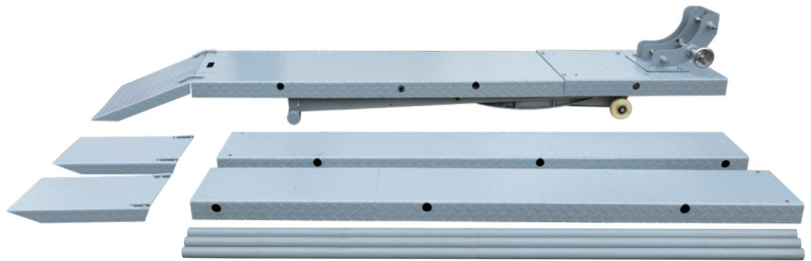

OPK-MP500

MOTORCYCLE LIFT

摩托车举升机



技术参数 Technical parameters

型号	Model	OPK-MP500
最大举升高度	Max. Lifting Height	32"
最低举升高度	Min. Lifting Height	7"
载重量	Lifting Capacity	1543 LBS
平台长度	Platform Length	84"-97"-110"
平台宽度	Platform Width	48"
举升时间	Lifting Time	30s
电压	Voltage	220/380V
设备净重	Net weight	705 LBS
包装尺寸	Packing Size	110" x 92" x 49"

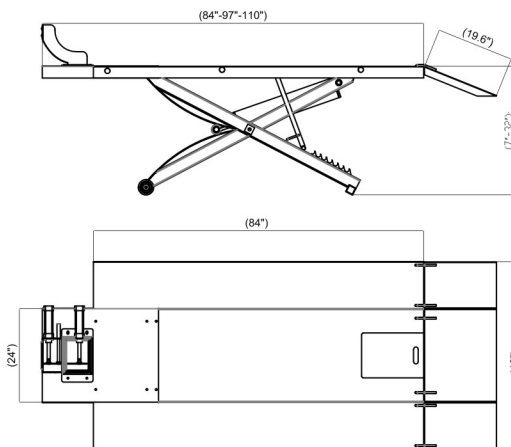

细节说明 Detail

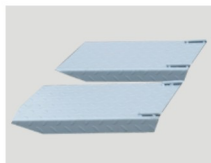

可拆卸上坡板
Removable Uphill slab



手动保险杆。
Manual release bar.



橡胶滚轮
Rubber roller

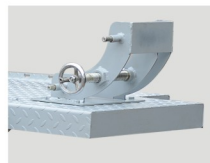

前轮固定架
Front wheel holder

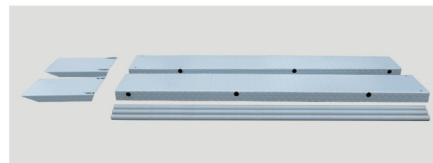

可拆卸加宽板
Removable widening plate

OPARCK

更多信息请登录 More information please login:
www.oparck.com www.sxdinggao.en.alibaba.com

绍兴鼎高机械设备有限公司
SHAOXINGDINGGAOMECHANICAL EQUIPMENT CO., LTD.

浙江省绍兴市袍江工业区马山路186号
NO.186 Mashan Road, Paojiang Industrial Zone, Shaoxing, Zhejiang, China
TEL: 0086-0575-84623366 FAX: 0086-0575-84623331
E-mail: lichao@dinggaomechanical.com



www.oparck.com



www.sxdinggao.en.alibaba.com



OPK-ME-500

MOTORCYCLE LIFT

More information please login
www.oparck.com
www.sxdinggao.en.alibaba.com

PRODUCT DESCRIPTION

- Pneumatic foot step control
- Side extensions-optional
- Front table extension-optional
- Fast lifting
- Pneumatic lifting cylinder
- Adjustable front wheel vise
- Rear wheel repair pit reverse



OPK-ME-500

MOTORCYCLE LIFT



Technical parameters

Model	OPK-ME-500(KG)	OPK-ME-1100
Max. Lifting Height	1200mm	47.2"
Min. Lifting Height	185mm	7.2"
Lifting Capacity	500kg	1100LBS
Platform Length	2200mm	86.6"
Platform Width	762mm	30"
Lifting Time	45s	45s
Voltage	110V/240V(Customizable)	110V/240V(Customizable)
Net weight	300kg	661 LBS
Packing Size(Subject)	2300*830*320mm	90.5"*32.6"*12.5"
Packing Size(Hand operated accessories)	590*410*430mm	23.2"*16.1"*16.9"
Packing Size(Automatic accessories)	590*410*370mm	23.2"*16.1"*14.5"

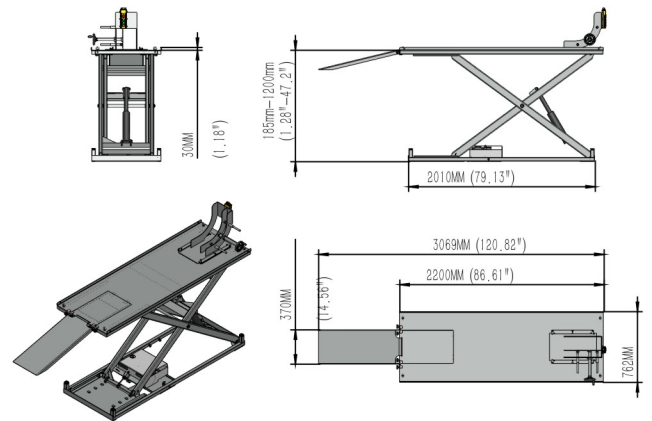

Detail



OPARCK

More information please login:
www.oparck.com www.sxdinggao.en.alibaba.com

SHAOXINGDINGGAOMECHANICAL EQUIPMENT CO., LTD.

浙江省绍兴市袍江工业区马山路186号
 NO.186 Mashan Road, Paojiang Industrial Zone, Shaoxing, Zhejiang, China
 TEL: 0086-0575-84623366 FAX: 0086-0575-84623331
 E-mail: lichao@dinggaomechanical.com



www.oparck.com



www.sxdinggao.en.alibaba.com



OPK-ME-1000

MOTORCYCLE LIFT

More information please login
www.oparck.com
www.sxdinggao.en.alibaba.com

PRODUCT DESCRIPTION

- Pneumatic foot step control
- Side extensions-optional
- Front table extension-optional
- Fast lifting
- Pneumatic lifting cylinder
- Adjustable front wheel vise
- Rear wheel repair pit reverse



OPK-ME-1000

MOTORCYCLE LIFT



Technical parameters

Model	OPK-ME-1000(KG)	OPK-ME-2200-W
Max. Lifting Height	1200mm	47.2"
Min. Lifting Height	210mm	8.2"
Lifting Capacity	1000kg	2200LBS
Platform Length	2200mm	86.6"
Platform Width	762mm+381mm+381mm	30"+15"+15"
Lifting Time	45s	45s
Voltage	110V/240V(Customizable)	110V/240V(Customizable)
Net weight	460kg	1014 LBS
Packing Size(Subject)	2300x830x430mm	90.5"x32.6"x16.9"
Packing Size(Hand operated accessories)	610x470x450mm	24"x18.5"x17.7"
Packing Size(Automatic accessories)	590x410x370mm	23.2"x16.1"x14.5"

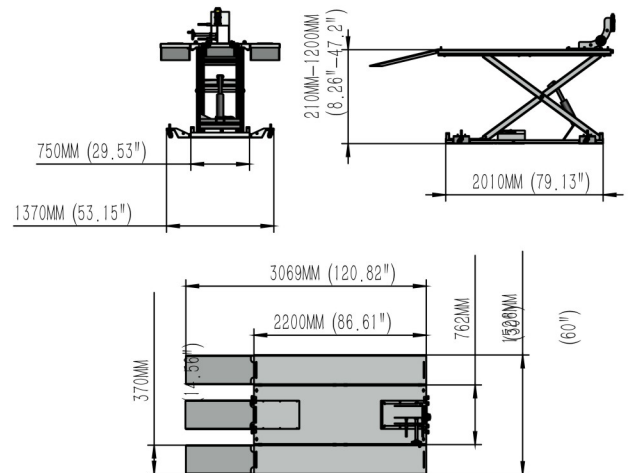

Detail



OPARCK

More information please login:
www.oparck.com www.sxdinggao.en.alibaba.com

SHAOXINGDINGGAOMECHANICAL EQUIPMENT CO., LTD.

浙江省绍兴市袍江工业区马山路186号
 NO.186 Mashan Road, Paojiang Industrial Zone, Shaoxing, Zhejiang, China
 TEL: 0086-0575-84623366 FAX: 0086-0575-84623331
 E-mail: lichao@dinggaoemecanical.com



www.oparck.com



www.sxdinggao.en.alibaba.com



OPK-509

TIRE CHANGER

轮胎拆装机

产品说明

- 24寸加大盘适用于拆装更大，更宽的轮胎
- 机器整体加宽，加厚，使操作更轻松，便捷
- 气动控制立柱后倾，自动定位，气动锁紧功能
- 预留辅助手安装孔位，可以随机加装辅助臂

PRODUCT DESCRIPTION

- Pneumatically operated tilting column
- Capable of handling stiff,wide and low-profile tire
- The clamping jaws and mounting,demounting head armad of high quality alloy steel,and scientific structural design protects steel rim from and damage during operation



OPK-509

TIRE CHANGER

轮胎拆装机

技术参数 Technical parameters

型号	Model	OPK-509
工作电压	Power supply	110V/220V/380V 50/60HZ
电机功率	Motor power	0.8KW/1.1KW
工作气压	Operating pressure	0.8-1MPa
外夹尺寸	Outside clamping	11-21"/279-533mm(11-23" optional)
内撑尺寸	Inside clamping	13-24"/330-610mm(13-26" optional)
最大轮辋直径	Max.wheel diameter	41"/1100mm
最大轮辋宽度	Max.wheel width	13"/330mm
压胎铲力	Bead break force	2500Kgf
工作气压	Operating pressure	8-10bar
噪音	Noise	<70db
净重/毛重	Net/Cross weight	220/240kgs
包装尺寸	Packing size	1000×800×950mm



细节说明 Detail

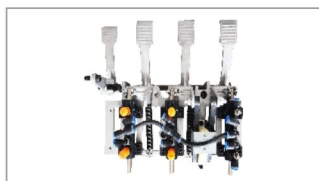

铝制脚踏总成
Aluminium Pedal Assembly



带硅钢片大盘
Wear-resistant plate for turntable



大功率电机
High-power motor



铝制小气缸
Aluminium small cylinder

标准配件 Standard Accessories



变速箱总成 Complete gear box

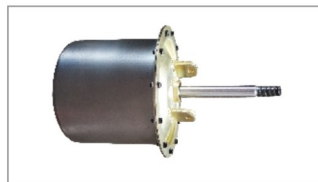

大气缸 Big cylinder

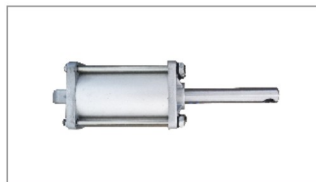

后仰立柱小气缸 Column small cylinder



电机 Motor



拆胎头 Mounting head



卡爪 Clamp



脚踏 Pedal



五通阀 Five way valve

OPARICK

更多信息请登录 More information please login:
www.shyinghaojx.com www.sxdinggao.en.alibaba.com

绍兴鼎高机械设备有限公司
SHAOXING DINGGAO MECHANICAL EQUIPMENT CO., LTD.

浙江省绍兴市袍江工业区马山路186号
NO.186 Mashan Road, Paojiang Industrial Zone, Shaoxing, Zhejiang, China
TEL: 0086-0575-84623366 FAX: 0086-0575-84623331
E-mail: lichao@dinggaomechanical.com



www.shyinghaojx.com



www.sxdinggao.en.alibaba.com



OPK-509A

TIRE CHANGER

轮胎拆装机

产品说明

- 气动控制立柱后倾, 自动定位, 气动锁紧功能
- 右辅助臂系统, 增大了工作覆盖面, 气动控制机械手可以自由升降定位锁定任意位置
- 气动托胎装置可平衡升降任意位置, 使拆装轮胎更加省力便捷
- 精密加工制造的减速器, 特殊合金制造的拆装头和卡爪, 使设备更经久耐用
- 小气缸直径75MM, 硬质氧化, 优质密封件, 镀铬活塞杆, 使其运行阻力小, 夹紧力更强

PRODUCT DESCRIPTION

- Pneumatically operated tilting column
- Simultaneous pneumatic horizontal and vertical arm locking
- Capable of handling stiff, wide and low-profile tire
- The clamping jaws and mounting, demounting head are made of high quality alloy steel, and scientific structural design protects steel rim from and damage during operation



OPK-509A

TIRE CHANGER

轮胎拆装机

技术参数 Technical parameters

型号	Model	OPK-509A
工作电压	Power supply	110V/220V/380V 50/60HZ
电机功率	Motor power	0.8KW/1.1KW
工作气压	Operating pressure	0.8-1MPa
外夹尺寸	Outside clamping	11-21"/279-533mm(11-23" optional)
内撑尺寸	Inside clamping	13-24"/330-610mm(13-26" optional)
最大轮辋直径	Max.wheel diameter	41"/1100mm
最大轮辋宽度	Max.wheel width	13"/330mm
压胎铲力	Bead break force	2500Kgf
工作气压	Operating pressure	8-10bar
噪音	Noise	<70db
净重/毛重	Net/Cross weight	280/310kgs
包装尺寸	Packing size	1000×800×950mm 1280×380×320mm



细节说明 Detail



合金卡爪 p75 气缸
Alloy clamp and p75 cylinder



带硅钢片大盘
Wear-resistant plate for turntable



大功率电机
High-power motor



加强右辅助臂
Reinforced right side help arm

标准配件 Standard Accessories



变速箱总成 Complete gear box

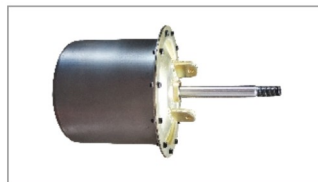

大气缸 Big cylinder

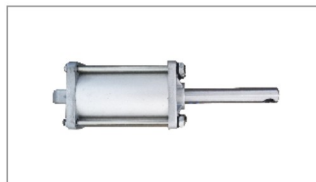

后仰立柱小气缸 Column small cylinder



电机 Motor



拆胎头 Mounting head



卡爪 Clamp



脚踏 Pedal



五通阀 Five way valve

OPARICK

更多信息请登录 More information please login:
www.shyinghaojx.com www.sxdinggao.en.alibaba.com

绍兴鼎高机械设备有限公司
SHAOXING DINGGAO MECHANICAL EQUIPMENT CO., LTD.

浙江省绍兴市袍江工业区马山路186号
NO.186 Mashan Road, Paojiang Industrial Zone, Shaoxing, Zhejiang, China
TEL: 0086-0575-84623366 FAX: 0086-0575-84623331
E-mail: lichao@dinggaomechanical.com



www.shyinghaojx.com



www.sxdinggao.en.alibaba.com



OPK-516A

TIRE CHANGER

轮胎拆装机

产品说明

- 右气缸辅助臂装置，使拆装轮胎时更加省力便捷
- 24寸加大盘适用于拆装更大，更宽的轮胎
- 精密加工制造的减速器，特殊合金制造的拆装头和卡爪，使设备更经久耐用

PRODUCT DESCRIPTION

- Pneumatic controlled tyre pressing device can be freely lifted and located at any position
- Tyre pressing roller of right help arm always protects tyre and rim
- Multi-function help arm has central positioning function which can make wheel and turntable homocentric



OPK-516A

TIRE CHANGER

轮胎拆装机

技术参数 Technical parameters

型号	Model	OPK-516A
工作电压	Power supply	110V/220V/380V 50/60HZ
电机功率	Motor power	0.8KW/1.1KW
工作气压	Operating pressure	0.8-1MPa
外夹尺寸	Outside clamping	11-21"/279-533mm(11-23" optional)
内撑尺寸	Inside clamping	13-24"/330-610mm(13-26" optional)
最大轮辋直径	Max.wheel diameter	40"/1000mm
最大轮辋宽度	Max.wheel width	13"/330mm
压胎铲力	Bead break force	2500Kgf
工作气压	Operating pressure	8-10bar
噪音	Noise	<70db
净重/毛重	Net/Cross weight	200/220kgs
包装尺寸	Packing size	1000×800×950mm



细节说明 Detail



合金卡爪p75气缸
Alloyclawand p75 cylinder



带硅钢片大盘
Wear-resistantplate for turntable



大功率电机
High-power motor



压胎上辅助臂
Tire press helparm

标准配件 Standard Accessories



变速箱总成 Complete gear box

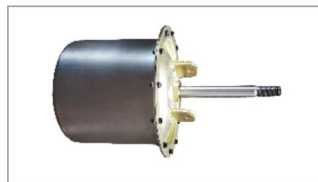

大气缸 Big cylinder

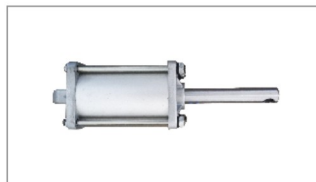

后仰立柱小气缸 Column small cylinder



电机 Motor



拆胎头 Mounting head



卡爪 Clamp



脚踏 Pedal



五通阀 Five way valve

OPARICK

更多信息请登录 More information please login:
www.shyinghaojx.com www.sxdinggao.en.alibaba.com

绍兴鼎高机械设备有限公司
SHAOXING DINGGAO MECHANICAL EQUIPMENT CO., LTD.

浙江省绍兴市袍江工业区马山路186号
NO.186 Mashan Road, Paojiang Industrial Zone, Shaoxing, Zhejiang, China
TEL: 0086-0575-84623366 FAX: 0086-0575-84623331
E-mail: lichao@dinggaomechanical.com



www.shyinghaojx.com



www.sxdinggao.en.alibaba.com



OPK-516

TIRE CHANGER

轮胎拆装机

产品说明

- 24寸加大盘适用于拆装更大，更宽的轮胎
- 精密加工制造的减速器，特殊合金制造的拆装头和卡爪，使设备更经久耐用

PRODUCT DESCRIPTION

- The enlarged 24inch turettable is suitable for mounting and demounting larger and wider tires
- Left help arm system makes the wider tires mounting and demounting operation much swift and labor saving
- Scientific and stable design to make sure the wheels and tires free of damage during operation



OPK-516

TIRE CHANGER

轮胎拆装机

技术参数 Technical parameters

型号	Model	OPK-516
工作电压	Power supply	110V/220V/380V 50/60HZ
电机功率	Motor power	0.8KW/1.1KW
工作气压	Operating pressure	0.8-1MPa
外夹尺寸	Outside clamping	11-21"/279-533mm(11-23" optional)
内撑尺寸	Inside clamping	13-24"/330-610mm(13-26" optional)
最大轮辋直径	Max.wheel diameter	40"/1100mm
最大轮辋宽度	Max.wheel width	13"/330mm
压胎铲力	Bead break force	2500Kgf
工作气压	Operating pressure	8-10bar
噪音	Noise	<70db
净重/毛重	Net/Cross weight	180/200kgs
包装尺寸	Packing size	1000×800×950mm



细节说明 Detail



合金卡爪p75气缸
Alloyclawand p75 cylinder



带硅钢片大盘
Wear-resistantplate for turntable

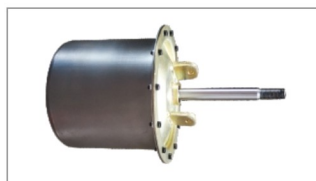

大直径铝活塞气缸
Large Diameter big piston cylinder



大功率电机
High-power motor

标准配件 Standard Accessories



变速箱总成 Complete gear box

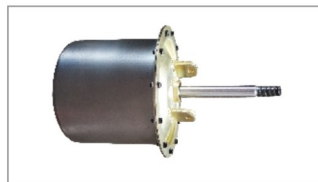

大气缸 Big cylinder

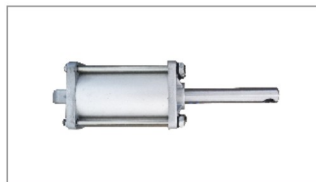

后仰立柱小气缸 Column small cylinder



电机 Motor



拆胎头 Mounting head



卡爪 Clamp



脚踏 Pedal



五通阀 Five way valve

OPARICK

更多信息请登录 More information please login:
www.shyinghaojx.com www.sxdinggao.en.alibaba.com

绍兴鼎高机械设备有限公司
SHAOXING DINGGAO MECHANICAL EQUIPMENT CO., LTD.

浙江省绍兴市袍江工业区马山路186号
NO.186 Mashan Road, Paojiang Industrial Zone, Shaoxing, Zhejiang, China
TEL: 0086-0575-84623366 FAX: 0086-0575-84623331
E-mail: lichao@dinggaomechanical.com



www.shyinghaojx.com



www.sxdinggao.en.alibaba.com



OPK-996 WHEEL BALANCER

轮胎平衡机

产品说明

- 紧凑型箱体设计，小巧精致
- 自校准功能和设备故障自检功能
- 静平衡，标准动平衡及特殊形状轮辆平衡
- 带有车轮旋转保护罩，安全可靠
- 不平衡值精确显示，明确指示平衡块填加位置

PRODUCT DESCRIPTION

- Self calibrating and self diagnosis programs
- Static and standard dynamic balancing and special rim balancing
- It is safe and reliable with wheel protection cover Unbalance value displayed accurately, and the position to add the balance weight is indicated definitely



OPK-996

WHEEL BALANCER

轮胎平衡机

本机可选配防护罩
THE PROTECTIVE COVER
IS OPTIONAL

技术参数 Technical parameters

型号	Model	OPK-996
工作电压	Power supply	110V/220V/380V 50/60HZ
电机功率	Motor power	0.5KW
轮辋直径	Rim diameter	12-24"
轮辋宽度	Rim width	1.5-20"/40-510mm
最大轮径	Max.wheel diameter	960mm
最大轮重	Max.wheel weight	70kg
平衡精度	Balancing precision	±1g
平衡周期	Cycle time	8s
噪音	Noise	<70db
净重/毛重	Net/Cross weight	180/200kgs
包装尺寸	Packing size	1000×800×950mm



标准配件 Standard Accessories



高精度加长主轴
High precision lengthening shaft

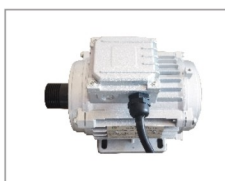

电机
Motor



标配椎体
Standard cones



开合螺母
Quick lock nut

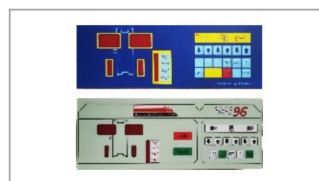

按键板
Key board



全自动电脑板
Circuit board



半自动电脑板
Circuit board



平衡钳
Counter plier



卡尺
Wheel width calliper

可选配件 Optional Accessories

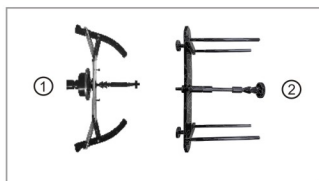

摩托车夹具
Motorcycle adaptor of wheel balancer



万能夹具
Universal adaptor



加大锥套
Large centring cone



精美保护罩
Delicate plastic hood

OPARICK

更多信息请登录 More information please login:
www.shyinghaojx.com www.sxdinggao.en.alibaba.com

绍兴鼎高机械设备有限公司
SHAOXING DINGGAO MECHANICAL EQUIPMENT CO., LTD.

浙江省绍兴市袍江工业区马山路186号
NO.186 Mashan Road, Paojiang Industrial Zone, Shaoxing, Zhejiang, China
TEL: 0086-0575-84623366 FAX: 0086-0575-84623331
E-mail: lichao@dinggaomechanical.com



www.shyinghaojx.com



www.sxdinggao.en.alibaba.com

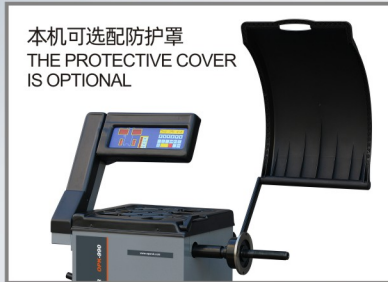

OPK-990

WHEEL BALANCER

轮胎平衡机

产品说明

- 紧凑型箱体设计，小巧精致
- 自校准功能和设备故障自检功能
- 静平衡，标准动平衡及特殊形状车辆平衡
- 带有车轮旋转保护罩，安全可靠
- 不平衡值精确显示，明确指示平衡块填加位置

PRODUCT DESCRIPTION

- Self calibrating and self diagnosis programs
- Static and standard dynamic balancing and special rim balancing
- It is safe and reliable with wheel protection cover Unbalance value displayed accurately, and the position to add the balance weight is indicated definitely



OPK-990

WHEEL BALANCER

轮胎平衡机

本机可选配防护罩
THE PROTECTIVE COVER
IS OPTIONAL



技术参数 Technical parameters

型号	Model	OPK-990
工作电压	Power supply	110V/220V/380V 50/60HZ
电机功率	Motor power	0.5KW
轮辋直径	Rim diameter	12-24"
轮辋宽度	Rim width	1.5-20"/40-510mm
最大轮径	Max.wheel diameter	960mm
最大轮重	Max.wheel weight	70kg
平衡精度	Balancing precision	±1g
平衡周期	Cycle time	8s
噪音	Noise	<70db
净重/毛重	Net/Cross weight	180/100kgs
包装尺寸	Packing size	950×570×1100mm

标准配件 Standard Accessories



高精度加长主轴
High precision lengthening shaft

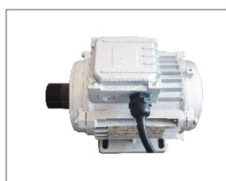

电机
Motor



标配椎体
Standard cones



开合螺母
Quick lock nut

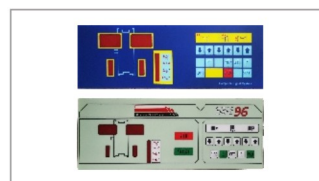

按键板
Key board



全自动电脑板
Circuit board

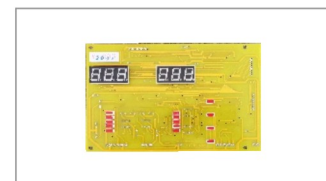

半自动电脑板
Circuit board



平衡钳
Counter plier



卡尺
Wheel width calliper

可选配件 Optional Accessories



摩托车夹具
Motorcycle adaptor of wheel balancer



万能夹具
Universal adaptor



加大锥套
Large centring cone



精美保护罩
Delicate plastic hood

OPARICK

更多信息请登录 More information please login:
www.shyinghaojx.com www.sxdinggao.en.alibaba.com

绍兴鼎高机械设备有限公司
SHAOXING DINGGAO MECHANICAL EQUIPMENT CO., LTD.

浙江省绍兴市袍江工业区马山路186号
NO.186 Mashan Road, Paojiang Industrial Zone, Shaoxing, Zhejiang, China
TEL: 0086-0575-84623366 FAX: 0086-0575-84623331
E-mail: lichao@dinggaomechanical.com



www.shyinghaojx.com



www.sxdinggao.en.alibaba.com



绍兴鼎高机械设备有限公司

地址: 浙江省绍兴市袍江工业区马山路186号
电话: 086-0575-84623366 传真: 086-0575-84623331
E-mail: lichao@dinggaomechanical.com

SHAOXING DINGGAO MECHANICAL EQUIPMENT CO., LTD.

ADD: NO.186 Mashan Road. Paojiang Industrial Zone. Shaoxing. Zhejiang.China
TEL: 086-0575-84623366 FAX: 086-0575-84623331
E-mail: lichao@dinggaomechanical.com

更多信息请登录:

More information please login:
www.dinggaojx.cn www.sxdinggao.en.alibaba.com

由于技术参数不断更新, 本宣传册内产品的特点和图片仅供参考, 产品以实物为准, 本公司保留最终解释权。
As the technical standards are constantly updated, the features of this brochure and the images in this information are for reference only.
The product is subject to the object. Our company reserves the right of final explanation.



www.oparck.com



www.sxdinggao.en.alibaba.com